

User Manual



KEY TRACKER®



KEY | **KEY**
EQUIPMENT
& SUPPLY CO



KE | **KEY**
EQUIPMENT[®]
& SUPPLY CO.

keyequipment.com

SALES | RENTALS | SERVICE | PARTS

KANSAS CITY
6716 Berger Avenue
Kansas City, KS 66111
800-262-0149

ST. LOUIS
13507 NW Industrial Dr.
Bridgeton, MO 63044
800-325-4323

QR | **Quality**
RENTS[®]

qualityrentsequipment.com



KEY TRACKER®



TABLE OF CONTENTS



General Information

- Introduction 2
- Disclaimer of Liability 2
- Important Notices 2
- Prepare for Use 3
- Register Extended Warranty 3
- Programming Frequencies 4
- Transmitter Controls and Indicators 5
- Direct & Coupler/Flexicoupler Connection 6
- Inductive Connection 7
- Blind Search 7
- Selecting the Tracing Signal 8
- Receiver Controls and Indicators 9
- PathLink Controls 10
- Locating Modes 11
- Peak Locating Mode 11
- Null Locating Mode 12
- Left/Right Auto-Gain Mode 13
- Absolute Signal Strength 13
- Gain Level Indication 13
- Passive 50/60 Hz Locating 14
- Passive Radio Frequency Locating 14
- Passive Rectifier CP Locating 14
- Push Button Depth 15
- Depth Measurement 45 Degree Angle Method 16
- Current Measurement 16
- Tilted Magnetic Field Identification 17
- Locating a Sonde 18-19
- Sonde Depth Measurement 20
- Fault Locating 21
- STAFF Fault Finder Controls 22-23
- Faults Beneath Paved Services 24
- Key Tracker Receiver Specifications 25-26
- Warranty 27



Congratulations on the purchase of your new Key Equipment & Supply Co.® Key Tracker® Series Cable, Pipe & Fault Locator. The Key Tracker PLS Locator is specially designed to detect conductors such as buried pipes & cables. This device may detect buried power cables, CATV cables, gas and water pipes, sewer lines, telecommunication lines, fiber optic cables with sheath, sondes, inspection camera transmitters. You have chosen a quality product that is designed for years of field use without the need for annual or periodic calibration and service.

The basic principle of the locator's operation is as follows:

The TRANSMITTER emits a signal to a conductive cable or pipe. The RECEIVER detects the electromagnetic field that is generated by the transmitted signal. You can locate the relative position of the buried utility by following the tracing signal.











For safety & to help ensure the best locating results, please read & understand the manual in its entirety before using the product.



DISCLAIMER OF LIABILITY

Key Equipment & Supply Co.® and Quality Rents® shall not be liable to Distributor, Reseller, or any other person for any incidental, indirect, special, exemplary or consequential damages, or injury of any type whatsoever, and caused directly or indirectly by Products sold or supplied by Key Equipment & Supply Co. and Quality Rents.

IMPORTANT NOTICES

-  **WARNING!** Failure to follow these warning could result in serious injury or death.
-  **WARNING!** Only persons qualified and trained to operate cable & pipe locators may operate this equipment.
-  **WARNING!** Follow appropriate safety procedure, your companies policies and applicable safety codes and/or laws.
-  **WARNING!** Do not connect to utilities, cables or pipes without authorization and training.
-  **WARNING!** Use tool only for intended purpose as described in this manual.
-  **WARNING!** Do not expose tool to rain or moisture.
-  **WARNING!** Do not expose to hazardous chemicals, hazardous gas or explosive environment.
-  **WARNING!** SHOCK HAZARD - Lethal voltages may be present at the transmitter's output. Turn off transmitter before touching test lead or any un-insulated conductor. Make connection to ground and target conductor before turning on transmitter.
-  **WARNING!** SHOCK HAZARD - Do not connect to live voltage or active utility lines. De-energize any circuits in or around the work area.
-  **WARNING!** This tool is designed to detect electromagnetic field emitted from cables and buried metallic utilities. There are buried cables, pipes, and utilities this instrument CANNOT detect.
-  **WARNING!** LOCATING is not an exact science. The only certain way to be sure of the existence, location, or depth of buried utilities is to carefully expose (dig up) the utility.

Unpack your new Key Tracker Locator. Make sure there is no shipping damage and all the parts are included.

Locate the battery compartment on the back of the of the RECEIVER and on the bottom of the TRANSMITTER. Open the compartments using a Phillips screwdriver. If your unit is a rechargeable system, remove the terminal isolation paper to allow the battery spring to contact the battery terminal. If the unit is configured for alkaline batteries, Install the six alkaline Duracell® "C" batteries as marked in the RECEIVER and twelve Duracell® "D" batteries as marked in the TRANSMITTER.

For rechargeable units, please charge for at least 5 hours before use. Remove the terminal isolation paper inside the battery compartments to allow the battery spring to contact the battery terminal.

Note: For longer battery life and reliable operation under adverse conditions, use only Duracell® alkaline batteries.

Note: The battery type used must be selected in the programming menu of the transmitter and the receiver. For instructions on how to select please see page 4.

REGISTER EXTENDED WARRANTY

By registering your unit online at <http://www.rycominstruments.com/extended.html> within one month (30 Days) of purchase RYCOM will extend the warranty period from one year to 4 years.

This instrument is under warranty for one year from the date of delivery against defects in material and workmanship (**EXCEPT BATTERIES**). We will repair or replace products that prove to be defective during warranty period.

This warranty is void if, after having received the instrument in good condition, it is subjected to abuse, unauthorized alterations or casual repair.





No other warranty is expressed or implied. The warranty described in this paragraph shall be in lieu of any other warranty, including but not limited to, any implied warranty of merchantability or fitness for a particular purpose. We are not liable for consequential damages.



The Key Tracker operating modes, frequencies and other functions are user programmable and can be changed at anytime through a quick selection process in the programming menu.



RECEIVER

To select the programming options for software versions 5.7 and greater:

- With the unit on, press and hold the **Power On** button for 4 seconds. Once released "Pro" will be displayed at the top of the LCD. 
- To scroll through the main menu headings, press the **Frequency Key**. *f*
- To enter a selection's sub-menu press the **Up Arrow (Gain Up)** key. 
- To browse a selection's menu, press the **Frequency Key**. *f*
- Once the desired option is selected, exiting the sub-menu will save the selection.
- To exit a selection's sub-menu use the **Down Arrow (Gain Down)** button. 
- Exit the programming menu from the main menu by pressing the **Power On** button. This return to the normal operation mode. 

TRANSMITTER

To select the desired frequency set for **software versions 3.43 and greater**:

- Press and hold depressed the Power On Button. 
- Pressing the Frequency Button will toggle through available configurations. Repeat pressing until 'u5' is displayed in the Frequency Indicator section of the LCD. *f*
- Release the Power On Button. 'Pro' will be displayed on the LCD.
- Press the Frequency Button to toggle through the available frequencies. *f*
- To select and store the desired frequency press and hold the Frequency Button for 2 seconds. The count of the selected frequency will be displayed on the LCD. *f*
- Continue to toggle through and select the desired frequencies.
- Press the Power On Button to shut the unit off. This will save the selected frequencies for availability during normal operation. 



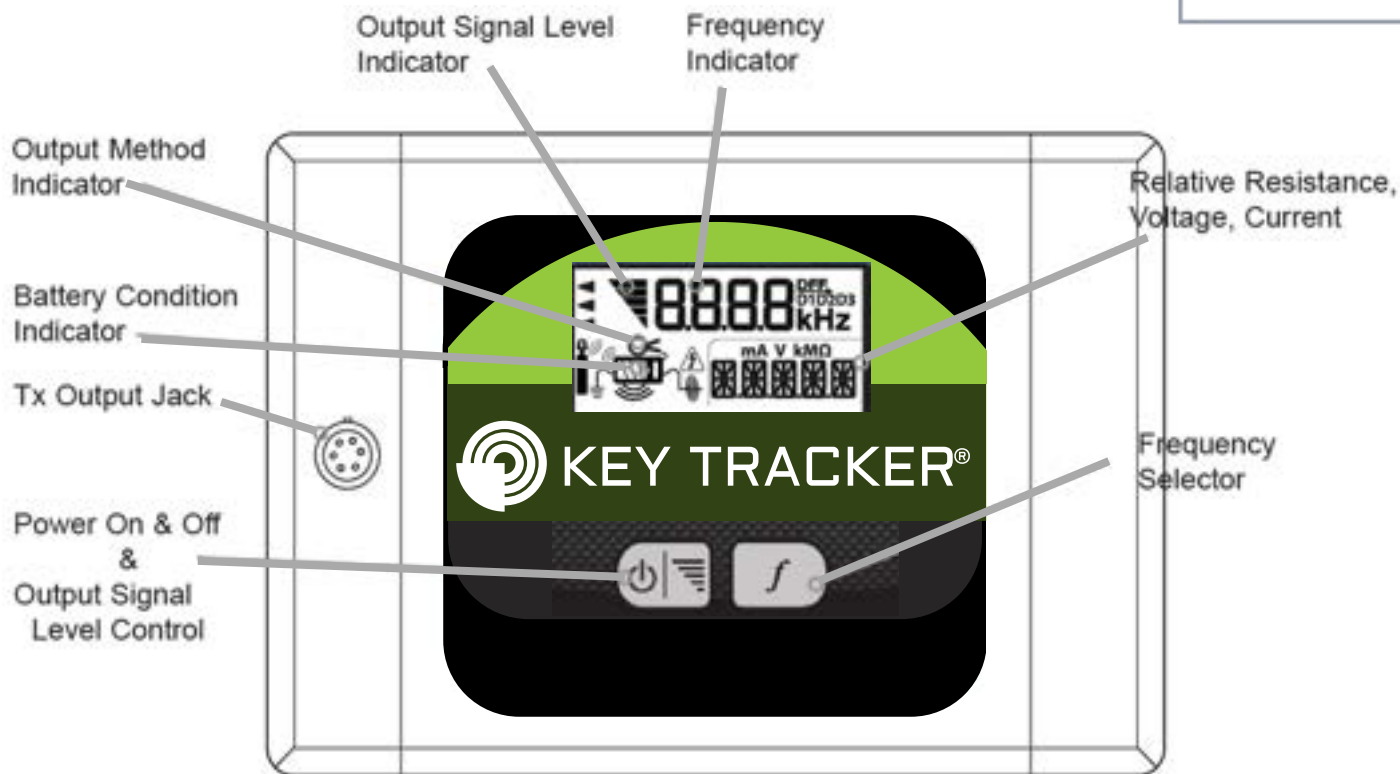

TX OUTPUT JACK

The Red/Black Cord, Coupler and Flexicoupler connects here to create a circuit on the buried utility.

FREQUENCY SELECTOR



This button toggles through the available frequencies. The selected frequency is displayed on the LCD. When dual frequency transmission options are selected, indicated by the D1 & D2 icons to the right large numeric segments, the frequencies will flash from one to another.

SIGNAL INDICATOR (visual & audible)

The Signal Indicator symbol flashes to indicate signal output. The quick triple beep audible tone indicates the circuit is open and no signal is being transmitted. A steady continuous beep indicates a closed circuit and signal is transmitted. When the indicator blinks 4 times per second, it is indicating a nearly short circuit. When the indicator blinks 1 time every 10 seconds, it is indicating a nearly open circuit.



ON/OFF & OUTPUT SIGNAL LEVEL CONTROL

The ON/OFF & OUTPUT SIGNAL LEVEL CONTROL turns the unit on. With a short press it will adjust the power output from the Transmitter. There are 3 selections on the standard power settings. Holding down the Output Signal Level button for 2 Seconds will turn the unit off.



WARNING! High Power Output is a **SHOCK HAZARD** - Lethal voltages at the transmitter's output. Turn off transmitter before touching test lead or any un-insulated conductor. Make connection to ground and target conductor before turning on transmitter.

SIGNAL INFORMATION SELECTOR

The unit can display the relative resistance, current and voltage of the transmitted signal. The resistance is based on the feed back from the selected frequency and is not an actual impedance meter. The selections can be toggled by pressing the **SIGNAL INFORMATION** button.

 **CAUTION** DO NOT CONNECT TO LIVE OR ENERGIZED POWER CABLES

Direct Connection is the most reliable method of signal application. This method is relatively free of interference. The greatest amount of signal strength can be achieved by this method. Low, mid, and high frequency may be used. The far end of the utility must be grounded.

Connect the Red Test Cord to an existing ground point or an exposed metallic section of the utility. Place the Ground Rod approximately 10 feet from this point, at an angle of 90° to the buried cable or pipe. Push the Ground Rod into the ground 8 to 10 inches. Connect the Black Test Cord to the Ground Rod.

Plug the Red/Black Test Cord into the TX OUTPUT JACK. Select the desired frequency. The Signal Output Indicator will flash once signal is established.

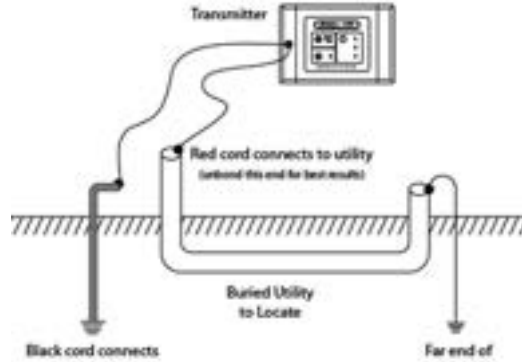

COUPLER & FLEXICOUPLER CONNECTION

The optional FLEXICOUPLER and HARD COUPLER are very easy to use, and services do not have to be interrupted. The operation range is shorter than for Direct Connection methods. The tracing signal can be affected by neighboring cables and pipes. The Red/Black TEST CORD or the GROUND ROD are not needed for this method.

Successful COUPLER operation requires an insulated conductor that is grounded on both near and far ends.

Loop the FLEXICOUPLER around the cable and connect the two ends, or clamp the HARD COUPLER around the cable. It is important to connect the COUPLER around the cable needing to be traced. Connect the COUPLER around the wire closer to the outgoing cable not near the system ground. The result will be a stronger signal. By connecting near the grounding, the range will also be shorter, and difficulty may arise determining one cable from another.

Plug the COUPLER into the TX OUTPUT JACK.

Some couplers are frequency specific, others can operate on medium and high frequencies.

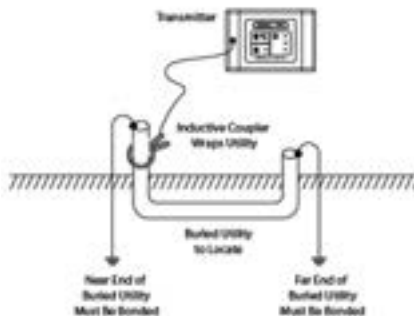

This method is convenient to use, and services are not interrupted. No test cords or connections are needed. The cable or pipe must have good insulation or non-conductive coating, or the operating range will be short.

Turn the TRANSMITTER ON. This method of signal application only works on frequencies from 33kHz through 478 kHz. **Place TRANSMITTER ON ITS SIDE** as close as possible to the path of the cable or pipe. Align the ARROWS on the SIDE OF THE TRANSMITTER in line with the cable or pipe. First, locate the broad TRANSMITTER Null, then move toward the expected cable path while looking for the signal carried by the cable.

Start tracing the path with the Receiver 25 feet from the TRANSMITTER. Search in the 90° zone as shown above. Locate the cable or pipe, and follow the path. If the signal becomes weak, move the TRANSMITTER to a point 25 feet behind the last strong signal, and continue searching.

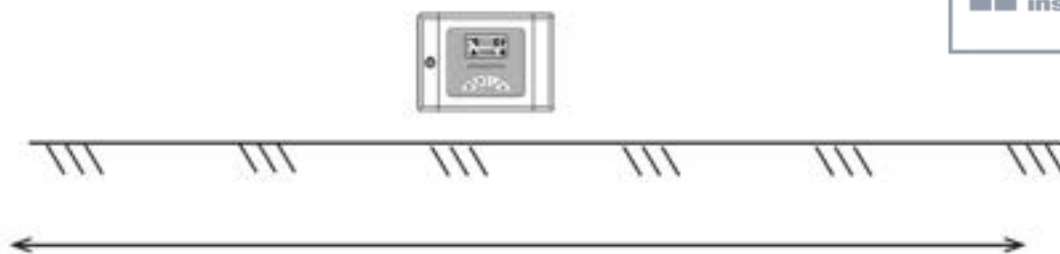

BLIND SEARCH

The Blind Search locating technique is used if the operator is not aware if a buried utility exists. Two people are needed for this technique. The TRANSMITTER and the RECEIVER are Held 25 feet away from each other. Each operator walks at the same speed keeping a distance of 25 feet from each other. When the receiver gives an audio response, then a buried utility is present between the RECEIVER and the TRANSMITTER.

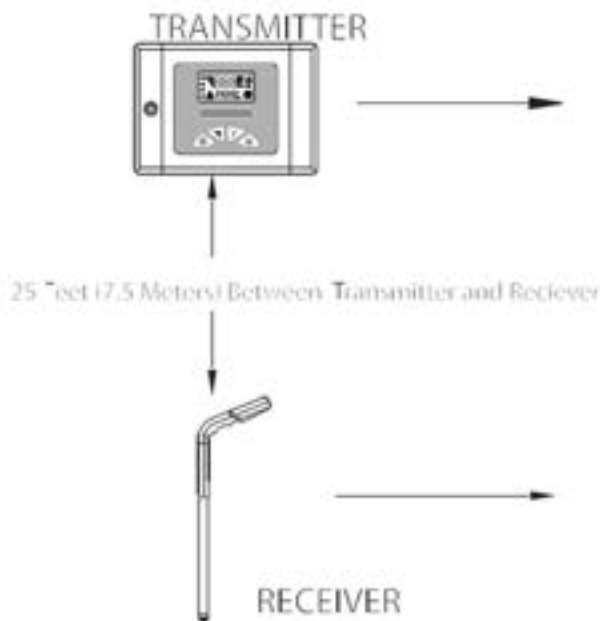

The choice of frequency is dependent on the conditions of the locate. It is generally accepted that lower frequencies provide a more accurate locate. Therefore it is generally advised to use the lowest frequency that effectively conducts on the target line. Lower frequencies are less likely to bleed onto adjacent non-target lines, but low frequencies are less effective at locating higher-resistant conductors.

FREQUENCY RANGES

Frequencies are classified into three major categories, Low, Medium and High and they are classified as follows:

• Low Frequencies	< 1 kHz (1000 Hz)	e.g. 512 Hz, 640 Hz, 815 Hz
• Medium Frequencies	1 kHz to 44 kHz	e.g. 4 kHz, 8 kHz, 33 kHz
• High Frequencies	44 kHz to 480 kHz	e.g. 65 kHz, 82 kHz, 200 kHz

FREQUENCY CHARACTERISTICS

The low, medium and high frequencies each have their advantages. It is recommended to begin by using a low frequency, and continue as long as you are confident in the results. If the signal is very weak try to adjust the connection or grounding. If there is no improvement in signal then try mid-range frequencies. Again, if there is weak or absent signal, repeat adjustments of the grounding and connection point before switching to a high frequency.

The method of signal application may dictate the frequencies used. While direct connection can be performed on any frequencies, coupler induction will only work with medium and high frequencies and transmitter induction will only work on the highest of the medium frequencies (33kHz) and high frequencies.

Low Frequencies are usually preferred to the mid-range frequencies and high frequencies because they are less susceptible to locating errors caused by coupling of signal to adjacent conductors, cables or pipes. The low frequency locating range is also much longer than the medium and high frequencies. Low frequencies will not travel well on highly resistive lines or conductors that have interruptions in their continuity (e.g. disconnected shield bonds or insulated pipe bushing). Low frequencies may only be applied via direct connection.

Medium Frequencies take the best of both high and low frequencies. Medium frequencies are not as susceptible to bleed off or coupling as the high frequencies, and medium frequencies can jump minor breaks in continuity and conduct on higher resistant lines better than low frequencies. It is still best to use low frequencies whenever effective, but 8 kHz and 33kHz are of the most common frequencies used in locating. Medium frequencies may be applied via direct connection and via coupler induction [Note: 33kHz may be applied via transmitter induction].

High frequencies are sometimes better than the low frequencies for locating highly resistant lines as well as conductors that have breaks in their continuity (e.g. disconnected shield bonds or insulated pipe bushing). The locating range is quite short for the high frequencies so the Transmitter must be repositioned more often during the tracing operation. High frequencies may be applied via direct connection, coupler induction and transmitter induction.



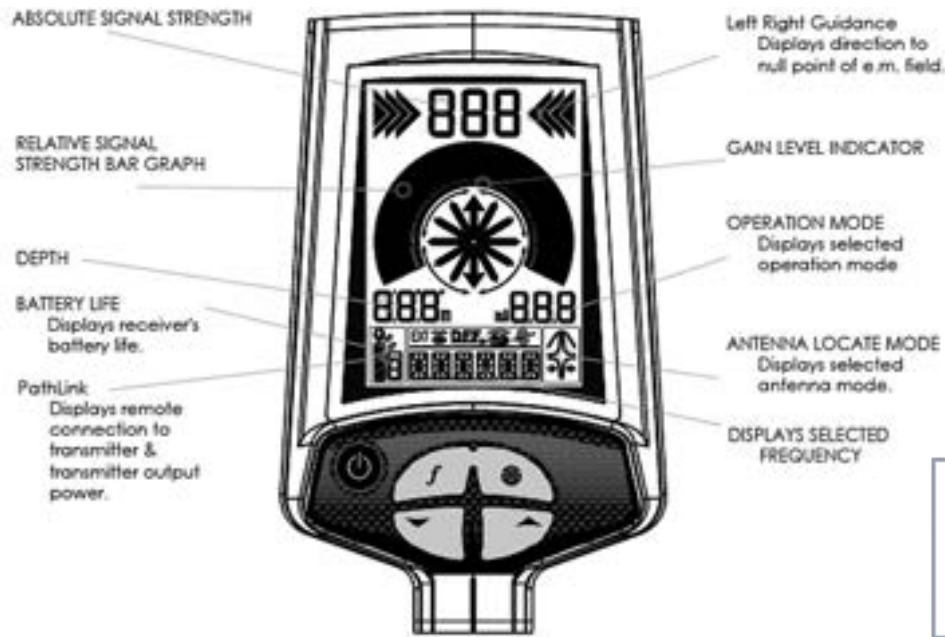

ON/OFF Button

This is a multi-use button that controls power on/off and enters the programming mode allowing the user to customize the operations of the system.

Unit On/Off - When off press once to turn the unit on. The unit will load settings from previous usage. Automatic shut off after 10 minute of no use.

Programming Mode - A long press of 3 seconds will enter the programming menu. A short press will exit the programming mode from the main menu.



Frequency - A short press of the Frequency/Function button toggles through available selected active and passive frequencies.

Note: Some frequencies are only available in certain modes and some modes will only be available with certain frequencies. The available selectable frequencies can be edited within the programing menu.



Mode Select - A short press will toggle through available modes. PEAK, PINPOINT PEAK, NULL, LEFT/RIGHT, and SONDE locating modes.

Note: The available selectable modes can be edited within the programing menu.



GAIN Button (Up or Down)

Adjusts the gain up or down. If the graph shows signal strength off scale, pressing the GAIN will automatically adjust to 50% on the scale display.

The optional PathLink feature enables the user to remotely control the transmitter with the receiver. The frequency and power output of the transmitted signal can be controlled up to 800 meters (874 yards).

If your unit does not have the PathLink module, the program will not allow the menu to select the option on.

Turning On and Off PathLink

- To turn on the remote control feature, PathLink, start with the unit on.



- Press and hold depressed the **Power On** button for 10 seconds.

- "Pro" will display at the top of the LCD.



- Using the FREQUENCY key scroll through the primary menu to "P-Link".



- Use the GAIN UP key to select the P-Link Menu.



- Use the FREQUENCY key to select the to select P-Link "on" or "off".



- Exit the P-Link Menu submenu by pressing GAIN DOWN.



- To exit the Programming menu and return to locating, short press the **On/Off - Function** key.



- In a moment the PathLink Indicator will be displayed on the receiver LCD indicating the unit has linked with the transmitter.

Changing the transmitted frequency with PathLink



Select the desired active frequency by pressing the Frequency key. Once the desired frequency is selected, the icon of the transmitter will flash momentarily then becoming solid confirming the selected frequency has been set at the transmitter. If the transmission is incomplete or if the frequency requested is not available, then the symbol will continue to flash and 'Err' with display momentarily displays on the receiver's LCD.



There is a variety of locating modes available in the Key Tracker unit. PEAK, PINPOINT PEAK, NULL LEFT/RIGHT GUIDANCE, SONDE, DFF & ACC. To toggle through PEAK, PINPOINT PEAK & NULL simple press the mode button. To toggle to SONDE mode hold the MODE button for 5 seconds and release. DFF and ACC modes are only selectable when an appropriate accessory is plugged into the accessory port in the handle of the receiver.

PEAK MODE LOCATING

Peak and Pin Point Peak modes have less error rates than the null locating mode in most circumstances. The peak mode location indication should be verified by the null to ensure locating accuracy.

With the RECEIVER in a vertical position. Move the RECEIVER left to right across the path. When the RECEIVER is directly above the cable or pipe, rotate the RECEIVER for a maximum signal. As you move the RECEIVER away from the cable path, the meter reading (and audio frequency response) will drop off.

The Left/Right arrows operate off of the Null reading. By utilizing the Left/Right arrows while in Peak mode the user can simultaneously locate in both modes thus quickly identifying the match or discrepancy between the Peak and the Null reading.

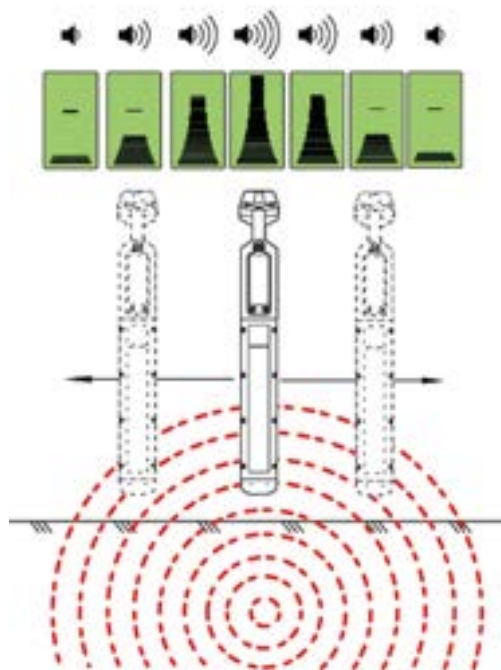

If you rotate the RECEIVER while over the cable, a sharp NULL will identify the cable's direction. It is aligned with the flat side of the RECEIVER.

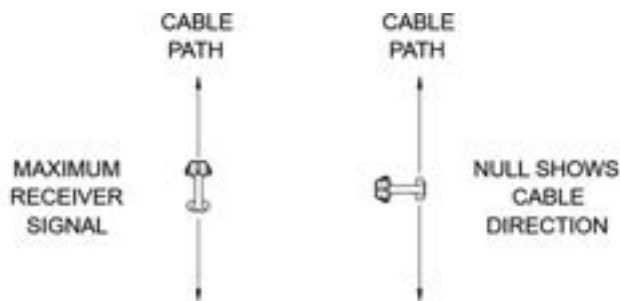

Trace the path by walking away from the TRANSMITTER at a moderate pace. Move the RECEIVER to the left and right while walking, following the PEAK indications.

As you trace the path, the PEAK meter reading may slowly fade as you move away from the Transmitter. Press and release the GAIN buttons as needed to compensate for changes in level (higher or lower). One of the following may occur:

- a) a junction where the signal divides and goes several directions.
- b) a break in the cable or shield.
- c) a change in the depth of the cable or pipe.
- d) an insulated pipe fitting.
- e) a slack loop of cable.

If you can no longer trace the path, even with the GAIN set to maximum, connect the TRANSMITTER to the far end of the path and trace back to the point where you lost the signal.

Mark the straight sections of the path every few feet. Mark sharp curves, loops, and cable bundles every few inches. Sharp changes in the path cause the RECEIVER PEAK and NULL indications to behave differently than when tracing a straight path. Practice on the path that you know has turns and laterals in it. This will help you to recognize the conditions within the field.

NULL MODE LOCATING

Move the RECEIVER left to right across the cable path. When the RECEIVER is directly above the cable or pipe, a NULL (lowest meter reading and lowest audio tone) will occur. When moving the RECEIVER to left or right of the NULL point, the meter reading will rise to a maximum point (PEAK). The audio tone will also be at its highest pitch. When the RECEIVER is moved beyond the PEAK, the meter reading will begin to fade.

Trace the path by walking away from the TRANSMITTER at a moderate pace. Move the RECEIVER to the left and right when walking, following the NULL indications.

It is expected that in areas of distortion and interference the Null locating mode will have a greater error rate than the Peak locating mode.

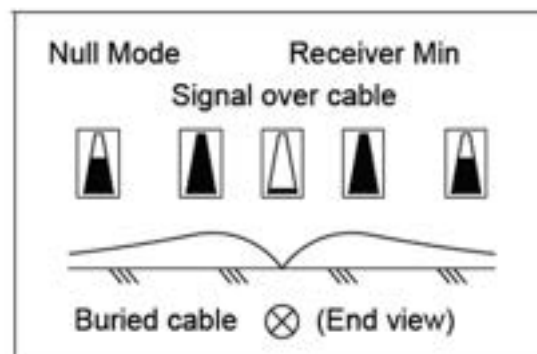

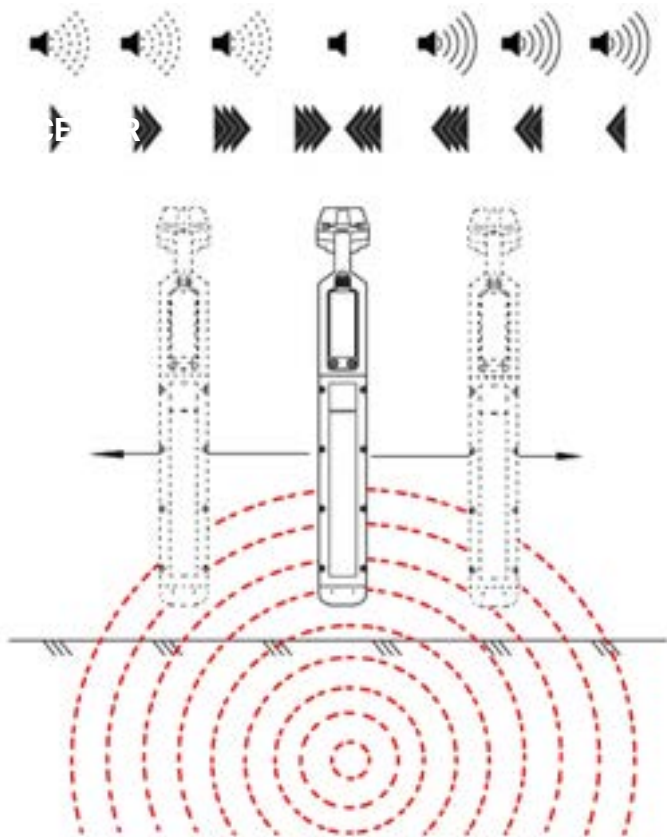

In this mode the unit will display directional arrows to the conductor. The audio indicator will provide a solid tone on one side of the conductor and a pulsed tone on the opposite side of the conductor. When the unit is centered in the electromagnetic field the tone will null and the depth will briefly display at the top of the LCD. This mode is gain independent.

The Left/Right arrows operate off of the Null reading and will have the same error rate as the Null locating mode. By utilizing the Left/Right arrows with the absolute signal strength reading the user can simultaneously locate with both Peak and Null modes, thus quickly identifying the match or discrepancy between the Peak and the Null reading.



ABSOLUTE SIGNAL STRENGTH

The Key Tracker RECEIVER provides the operator with a direct measurement of the Receiver's signal strength. The measurement is displayed with three numerical digits (ex: 485) located at the top of the LCD display. The measurement range is from 0 to 999 indicating a very weak signal (0) to a very strong signal (999). Absolute Signal Strength is independent of the GAIN setting or meter reading. It gives the operator information about the actual amount of signal being radiated from the conductor and received by the RECEIVER.

Measuring Absolute Signal Strength at any time is done by reading the number at the top of the LCD display. The Absolute Signal Strength will not be displayed if the meter reading is too high or too low. Adjust the GAIN to move the meter reading to mid-scale. The numerical display will change from '---' to a valid measurement.

Absolute Signal Strength measurements are more sensitive to signal changes than the meter display. PEAKS and NULLS can be more precisely pin-pointed. This measurement can also be used to monitor signal loss as the conductor is being traced.

GAIN LEVEL INDICATION

The GAIN up and down buttons are used to increase and decrease the gain in small amounts. If the meter reading is very low, pressing the GAIN up button will center the meter reading to mid-scale. Likewise, if the meter reading is very high, pressing the GAIN down button will center the meter reading to mid-scale.

The Key Tracker RECEIVER is capable of locating power utility frequencies. This MODE is useful for locating underground primary and secondary power utilities. In certain circumstances, this MODE will also locate water pipes, sewer lines, cable television, and telephone. The reason is that common electrical grounds are sometimes found among these various utilities. Select 50Hz or 60Hz frequency on the Receiver. PINPOINT PEAK mode will automatically be selected as the preferred method to locate the conductor in passive power mode.

This method is useful because of its speed and convenience. Start at a known reference point and keep in mind that other conductors in the area may produce this same locating signal.

The TRANSMITTER is not required to locate in this mode.

Note: The unit of depth measurement determines the selection of either 50Hz or 60Hz passive mode. The unit is configured for 50Hz when in Metric Measurement mode and 60Hz when in English Measurement Mode. To change unit of measurement press and hold the frequency button for 10 seconds, when released the unit will toggle measurement units.

PASSIVE RADIO FREQUENCY LOCATING

The Key Tracker RECEIVER is capable of passively locating metallic utilities where radio frequencies have coupled to the utility. This mode is useful for sweeping a green area for utilities. In certain circumstances, this mode will locate water pipes, cable television, gas lines and telephone. This locating option does not always detect buried utilities even when radio frequencies are present. This method is useful because of its speed and convenience. Start at a known reference point and keep in mind that other conductors in the area may produce this same locating signal.

The TRANSMITTER is not required to locate in this mode.

PASSIVE RECTIFIER CP LOCATING

The Key Tracker RECEIVER is capable of locating the rectified signal of Cathodically Protected utilities at 120Hz and 100Hz. This method is useful because of its speed and convenience. Start at a known reference point and keep in mind that other conductors in the area may produce this same locating signal.

Note: The unit of depth measurement determines the selection of either 100Hz or 120Hz passive mode. The unit is configured for 100Hz when in Metric Measurement mode (for 50Hz power) and 120Hz (for 60Hz power) when in English Measurement Mode. To change unit of measurement press and hold the frequency button for 10 seconds, when released the unit will toggle measurement units.

The TRANSMITTER is not required to locate in this mode.



The only way to be sure of the depth of a utility is to expose the utility. At any given time, the depth readout may be inaccurate.

The Key Tracker Receiver can perform digital depth measurement. The depth is displayed at the top of the LCD display in centimeters or feet and inches. Push button depth is useful in quickly estimating the depth of the conductor during path locating.

Begin this measurement by locating the path of the cable or pipe. Stay at least 15 feet (4.6 meters) away from the Transmitter. Pin-point this location as accurately as possible (see Peak Mode Locating page 19, Null Mode Locating page 20 and Absolute Signal Strength page 21). Place the Receiver vertically over the conductor and rest the foot of the locator on the ground. While holding the Receiver vertical, press and release the DEPTH button. The Receiver will briefly indicate a measurement is being performed and then display the depth at the top of the LCD display.

Caution must be exercised when using the push button depth feature, as tilted magnetic fields and adjacent conductors can significantly influence this measurement. The operator should periodically check for adjacent conductors and tilted magnetic fields when taking push button depth readings. For information on identifying tilted magnetic fields, refer to Tilted Magnetic Field Identification and Depth Measurement 45° Method.

Depth is determined by reading the electromagnetic field radiating from the conductor. The field must be even and circular for the most accurate reading. Interference of this field may be caused by bends in the cable, faults on the target conductor and signals radiating from adjacent non-target conductors. Interference will warp the field and skew the depth reading. The only way to be sure of the depth of a utility is to expose the utility. At any given time, the depth readout may be inaccurate.

The following are methods and procedures that will aid in increasing the reliability and testing the accuracy of the depth reading:

- Take depth readings at least 5 yards from cable bends or depth changes. Follow the cable both forward 5 yards and backward 5 yards, ensuring the line is straight and there is a consistent signal strength reading.
- Check for non-target conductors within 5 yards of the target cable. Sweep the area looking for coupled signals into both the tracks and adjacent cables. Adjacent conductors carrying the locate signal can result in a 50% error rate of the depth reading.
- Test for interference in the magnetic field by comparing the PEAK location to the Null location. The determined cable position by these methods should be within 3 inches of each other. A greater disparity will indicate interference resulting in inaccurate depth.
- Place the receiver vertically over the conductor and perpendicular to the conductor. Rest the foot of the locator on the ground. Take several depth readings moving slightly across the perpendicular plane to the conductor looking for the lowest depth reading.
- Once the lowest depth reading is found, take several readings. Each reading should be within one inch of the other reading. Wider variation will indicate interference resulting in inaccurate depth.
- Lift the receiver up 12 inches and take a depth reading. The reading should reflect the change in distance accordingly. If not, interference is present resulting in inaccurate depth.
- Verify the depth reading using the triangulation method as described below:
 - Mark the path on the ground as precisely as possible using the Null method.
 - Place the Receiver on the ground with the LCD meter facing up. Position the unit so that the Bubble Level on top of the meter is centered (45°).
 - Pull the Receiver away from the cable path (at 90° to the cable path) keeping the Bubble Level centered.
 - When the receiver indicates a Null reading, mark the location of the receiver's foot.
 - The distance between the Receiver and the cable path is the depth of the pipe or cable. A false depth reading may be caused by nearby buried metallic objects, such as a second cable, pipe, sewer, fence or railroad track.
 - Confirm the depth measurement by repeating the above steps on the opposite side of the pipe or cable.
 - A variance greater than 5 inches in depth measurement may indicate interference from adjacent cables, pipes or other objects.

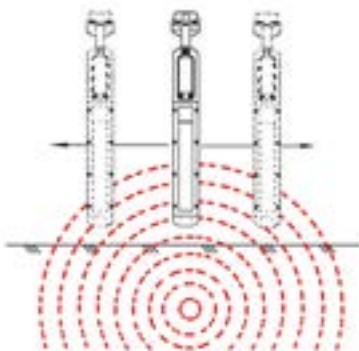

- Peak & Null readings match
- From the Peak/Null location take several readings across cable.
- Mark position indicated by lowest depth reading.
- While stationary take multiple depth readings.
- Reading should be consistent.

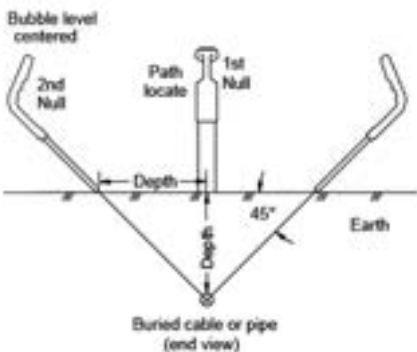
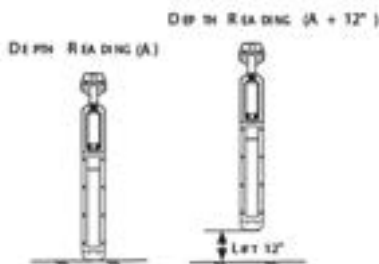

Move to the location you want to measure depth. Stay at least 15 feet away from the TRANSMITTER. Move the RECEIVER left to right across the path until the cable is located. Mark the path on the ground as precisely as possible using the Null Method.

Place the RECEIVER on the ground with the LCD meter facing up. Position the unit so that the BUBBLE LEVEL on top of the meter is centered (45°). Pull the Receiver away from the cable path (at 90° to the cable path) keeping the BUBBLE LEVEL centered. When the receiver indicates a NULL reading, mark the location of the receiver's foot. The distance between the RECEIVER and the cable path is the depth of the pipe or cable.

A false depth reading may be caused by nearby buried metallic objects, such as a second cable, pipe, sewer, fence or railroad track. Confirm the depth measurement by repeating the above steps on the opposite side of the pipe or cable.

A variance greater than 5 inches in depth measurement may indicate the presence of additional buried cables, pipes or other objects.

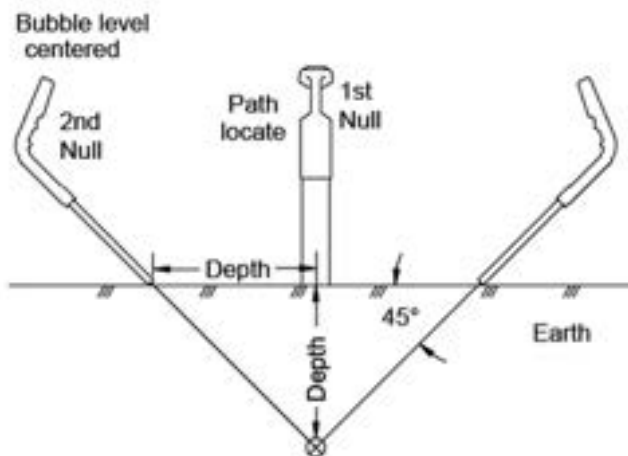

CURRENT MEASUREMENT

The Key Tracker RECEIVER contains a feature that is very useful in identifying a desired cable in a field of various conductors and/or utilities. It is not unusual for the target conductor (the conductor connected to the transmitter) to induce a signal into nearby conductors in a crowded field. In these instances, the radiated signal on the conductors close to the surface of the earth, may be stronger than the Transmitter signal on the target conductor buried deep in the ground. The operator will find two or more paths and must determine which is the target conductor. By using the current measurement feature of the Key Tracker RECEIVER, the operator can determine the amount of 815 Hz, 8 kHz, 33kHz or 82 kHz current flowing on the conductors, regardless of the depth. The highest current flow indicates the target conductor.

Place the RECEIVER vertically over one of the conductor marks and rest the foot of the locator on the ground. Holding the RECEIVER vertical, press and release the Shift Button & Depth button simultaneously. When the meter changes from a "thermometer" type display to a "bar" type display, hold the Receiver still until the measurement stabilizes. The blinking bar indicates the signal level on the cable (adjusted for depth). Next, move to the second cable and repeat the measurement. The blinking bar will show the signal level on the conductor. In addition, the previous reading is shown as a solid bar. The higher of these two readings will show which conductor is carrying the greatest locating signal.

When adjacent cables or pipes are present, they will sometimes create locating errors. Some of the Transmitter signal is picked up by the adjacent conductors and is redirected so that it combines with the original signal. The result is a Tilted Magnetic Field. This is often the reason that numeric depth readouts are sometimes created in error.

The operator can verify the accuracy of path locate by performing a variety of tests.

- The 45° Angle Method locate on both sides of the cable path. If the right and left side depth readings agree to within 5 inches, the path locate is accurate. If the two depth readings do not agree, then dig with care. A closer locate would be halfway between the two outside depth locate marks.
- Test for interference in the magnetic field by comparing the PEAK location to the Null location. The determined cable position by these methods should be within 3 inches of each other. A greater disparity will indicate interference resulting in inaccurate depth.

NOTE: The Left/Right arrows operate off of the Null reading. By utilizing the Left/Right arrows while in peak mode the user can simultaneously locate in both modes thus quickly identifying the match or discrepancy between the Peak and the Null reading.

These are important techniques that should be used to ensure the most accurate location possible.



Before you begin, you must choose a SONDE or CAMERA HEAD that will match the same frequency as the RECEIVER. You will need a SONDE with a frequency of 512Hz, 640Hz, 815Hz or 33kHz to use with the **Key Tracker** Locator Receiver.

To select SONDE locating mode press and hold the MODE key for 5 seconds. When released the SONDE ICON will be displayed on the LCD. Once in SONDE mode the FREQUENCY button will select the available SONDE frequencies.

The key to SONDE locating success is practice and patience. Before going out on your first locate, it is a good idea to take your RECEIVER and SONDE out and try locating the SONDE and calculating the depth.

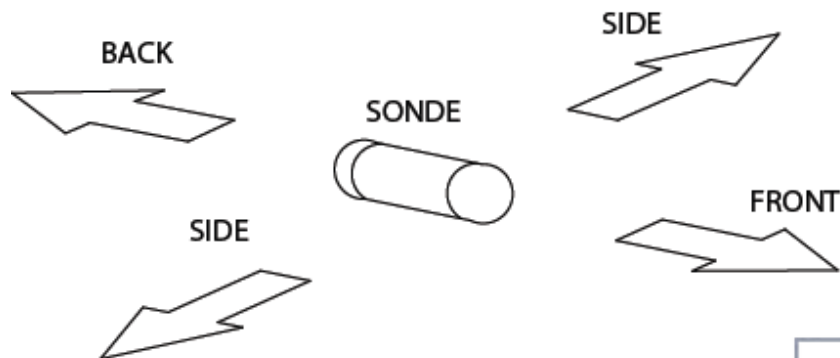

ATTACHING A PUSH DEVICE TO THE SONDE

Attaching a push rod to the SONDE can be accomplished by using the coupling on the end of the SONDE. A spring coupling is recommended to allow the SONDE to move easier. Or, if you need to attach the SONDE to a sewer auger, it is recommended you use duct tape and apply as the shown in the figure below. If taping the SONDE on a metal pushing device, it is recommended to place the battery side of the SONDE closest to the device. This will allow for the best performance. Wrap the snake for approximately 1 foot in the location where the SONDE is going to be attached. Also attaching the SONDE 18 inches behind the cutting head is recommended. First, wrap the SONDE in the duct tape and then attach the SONDE to the snake using the duct tape.

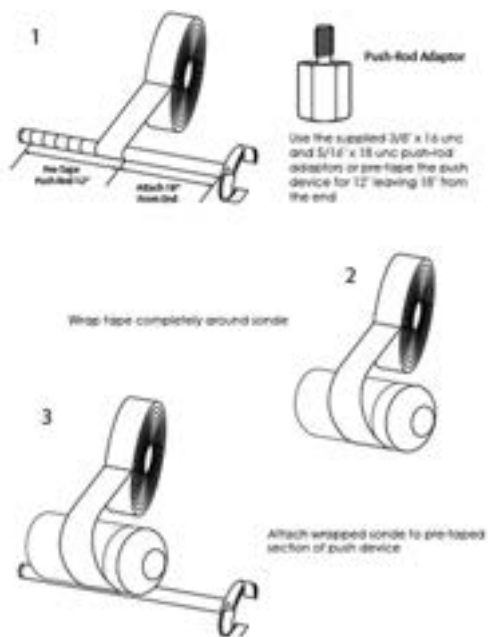

Hold the RECEIVER antenna directly above and in line with the SONDE, as shown below. The RECEIVER sensitivity needs to be adjusted for a meter reading indication between 60% to 80%.

The radiation pattern of the SONDE is shown below. The PEAK signal is when the RECEIVER is held directly over the SONDE with the antenna in line with the SONDE. Both Ghost signals can be located behind and in front of the SONDE. By locating the ghost signals, the user is confirming the accuracy of the locate.

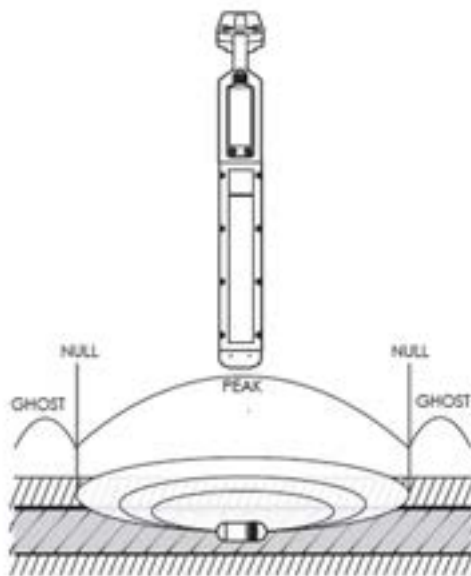

Start by following the suspected path of the pipe. Stop locating when the PEAK reading is found. Then rotate the RECEIVER as shown in the figure below. When pivoting the RECEIVER, do not change the vertical position. The RECEIVER will indicate a PEAK when the RECEIVER antenna is in line with the SONDE.

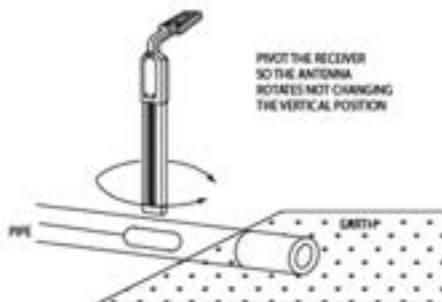

Now move the RECEIVER side to side (across the path of the pipe) as shown below. When the PEAK is found, the RECEIVER is directly over the SONDE. Mark this location. Next, check for ghost signals in front of and in back of the SONDE to confirm the location.

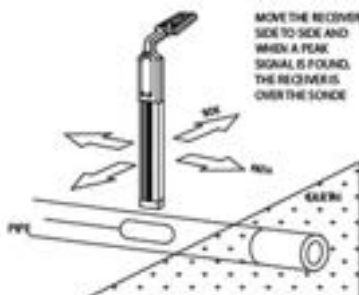

Once the Line has been located, the depth can then be found. Refer to the figure below for a reference. Start by moving the RECEIVER along the path behind the SONDE with the antenna in line with the SONDE and find a NULL between the PEAK ghost signals. Mark this point (A). Then move the Receiver along the path in front of the SONDE and find another NULL. Mark this point (B). Next, measure the distance between these two points. The depth of the pipe is 0.7 times the distance between the two points.

DISTANCE BETWEEN **A** AND **B** TIMES 0.7 EQUALS DEPTH OF SONDE.

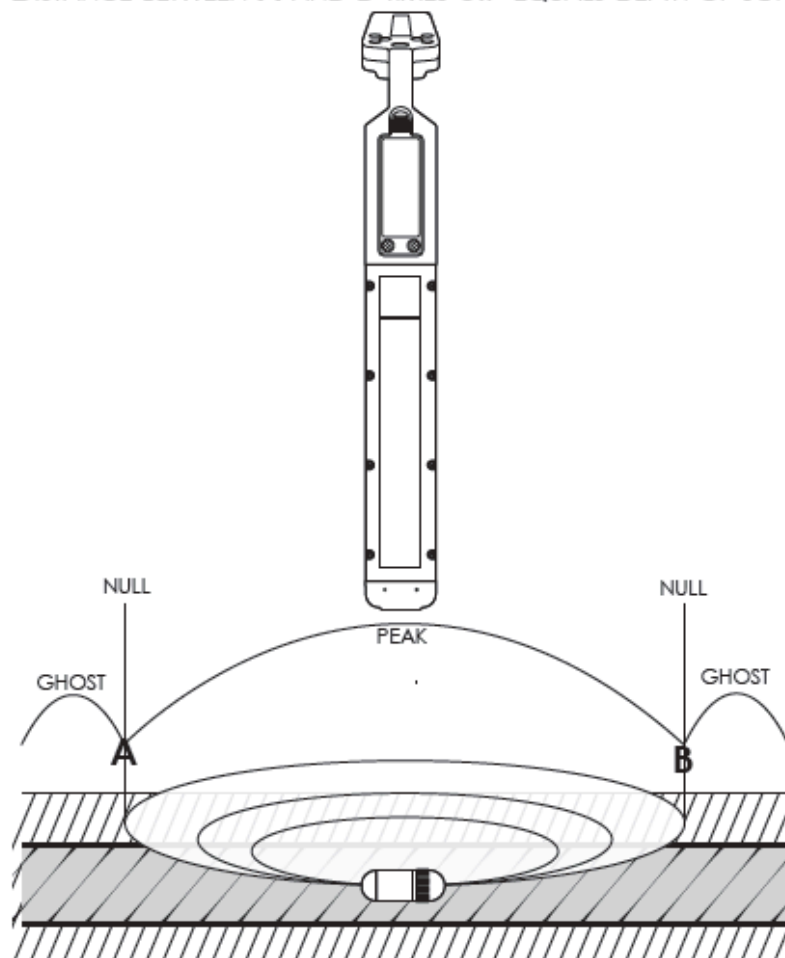

Ground Return Probe (GRP) Fault locating determines the position of an insulated break on an underground conductor. The Ground Return Probe detects the transmitted signal at the point (fault) where the signal goes to ground through a break in the insulation.

The Key Tracker transmitter can operate with the STAFF, a directional GRP locating system. A stand-alone devices, the STAFF, is capable of operating without needing to be tethered to the receiver.

STAFF RECEIVER CONTROLS AND INDICATORS

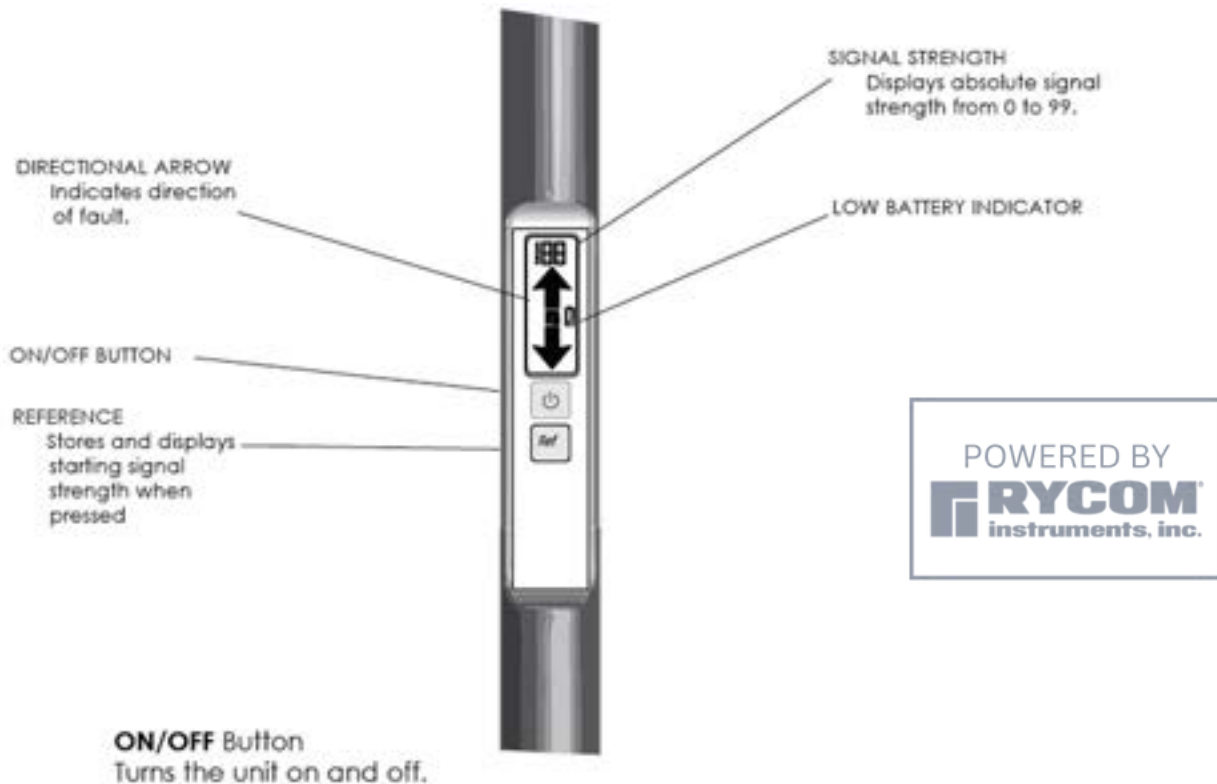

REFERENCE BUTTON

When pressed it stores the signal strength and sets the reference mode. The tone will beep more rapidly as the STAFF detects a similar signal strength. Pressing the reference button again (after a reference has been taken) will display the original reference reading for 2 seconds. Turn the unit off and on to clear the reference.

DIRECTIONAL ARROW

After proper synchronization the arrows will direct the user to the fault. If the signal strength drops completely off in the area between the ground rod and the fault, the arrows will not properly display direction until the unit comes within range of the fault or ground rod.

SIGNAL STRENGTH

The Signal Strength is displayed in a value from 0 to 100. The closer to the ground rod and/or the fault will result in the highest reading. The signal strength may drop completely off in the area between the ground rod and the fault.

LOW BATTERY

The STAFF Locator will indicate low battery condition by displaying the Low Battery icon on the LCD screen.

Locate the conductor path before attempting to fault locate. If, during the path locate, an unusual amount of signal loss occurs, this may indicate signal loss to ground within the immediate area. Lower frequencies will show a greater signal loss at a fault, but higher frequencies may be needed to locate if the resistance is too high.

Note: Signal will ground at a grounded splice point, which would act as a fault during the path and fault locate.

Once the path is determined, disconnect and isolate the far access point. Since the signal has no path to ground at the far access point, the signal will be forced to ground at the fault. This increases the current in the soil at the fault and eases the detection of the fault.

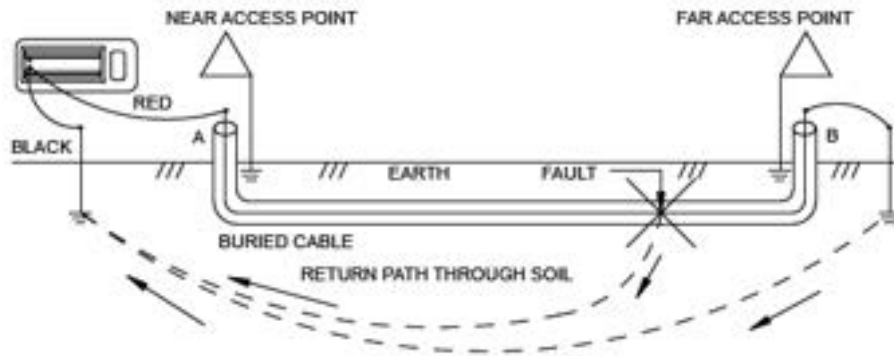

Set the Transmitter to fault mode by toggling the output frequency to DFF.

Note: If DFF is not a selectable frequency option refer to Programming section of this manual to add DFF to the transmitters operating frequencies.

Place the STAFF into the ground between the ground rod and the fault with the front spike toward the fault and the back spike toward the ground rod (approx. 1 yard or 1 meter from ground rod).

Turn the receiver or the STAFF on. As you walk the path using the GRP, place the probe every three or four steps. The STAFF's display will indicate the direction of the fault with arrows.

Once you pass the fault the arrows will flip direction.

The fault lies in the center of the Ground Return Probe spikes.



- Locate path of faulted conductor
- Remove power from faulted conductor & disconnect loads and ground from both ends of target conductor and neighboring conductors

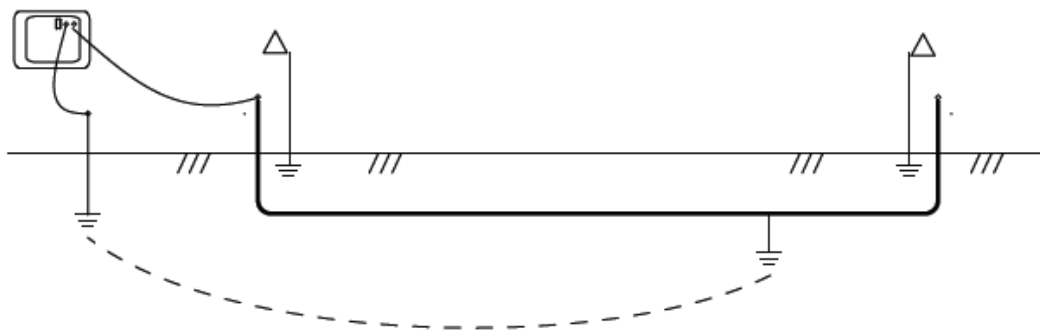

- With transmitter off connect red lead to the faulted conductor and black lead to independent ground rod placed behind and in line with the conductor path.
- Set the transmitter to DFF output mode by pressing the frequency key until DFF appears.
- Place STAFF in soil with back spike approx. 2 yards (2 meters) from ground rod and front spike toward suspected fault
- Note numeric reading as reference to signal strength near the ground rod.

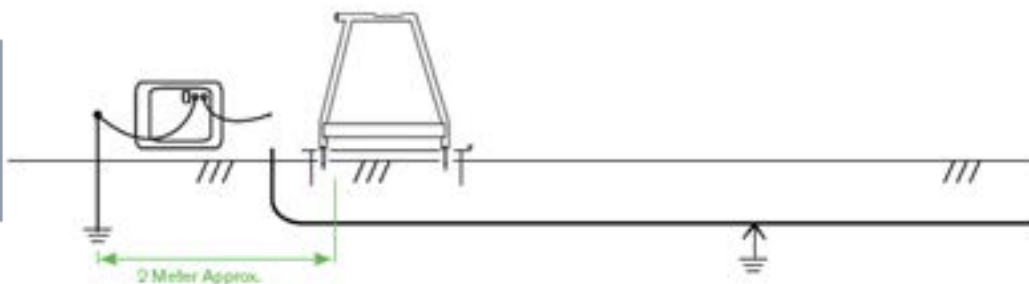

- LCD will indicate fault direction
- Signal strength reading will decrease with distance away from the ground spike. The signal reading and the arrows will likely become erratic as with distance. If the distance is great the signal strength may fall to non-detectable level and arrows may not stabilize through the center section (between ground rod and fault)
- Continue moving down the cable, taking readings every 3 to 5 feet. Once the STAFF enters the pool of signal at the fault, the signal strength will rise and the arrows will lock in.
- At the fault the signal strength will be equal to the signal strength at ground rod. The arrows will distinctly flip forward and backward as the fault is passed.

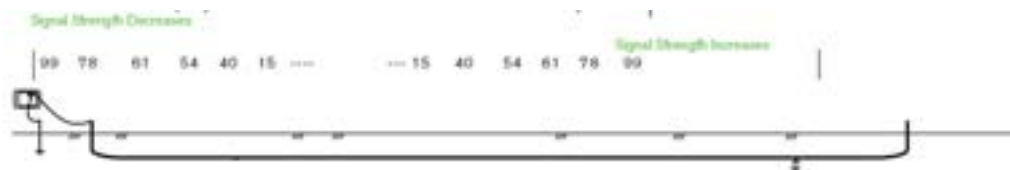

- The fault lies in the center of the Ground Return Probe spikes.

A potential problem could exist if a fault should lie beneath a paved surface. In this case, the Ground Return Probe or STAFF will be used in the dirt at the side of the paved area. Since the return current in the soil begins its return from the fault - like the spokes of a wheel laying on the ground - equal amounts of current will enter the GRP if it is placed on the ground and positioned broadside to the fault. At the point where the directional indication changes the fault will lie on a straight line projected at a right angle from the center of the GRP. The GRP adjustments can be made by slightly rotating the Ground Return Probe to find the directional change. The operator should record this line over the paved area. By repeating this procedure from another location near the paved area, another line will be produced. The intersection of the two lines is the location of the fault.

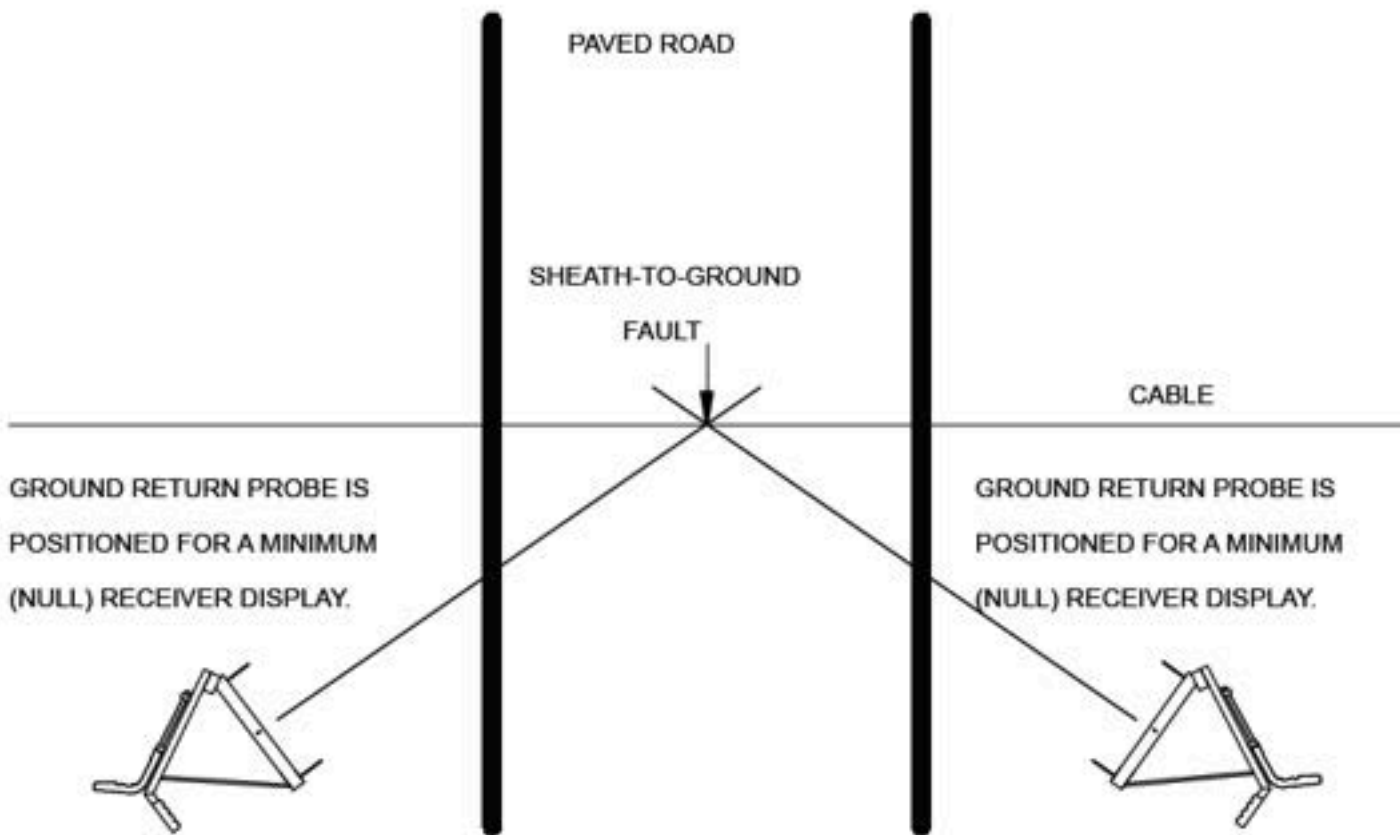

TRANSMITTER

Operating Frequency	200Hz - 480kHz
Operating Temperature	-4°F to 133° (-20°C to +55°C)
Hook-up Method	Direct Connection Inductive Coupling (with optional coupler) Transmitter Induction
Load Matching	automatic from 5 Ω to 20,000 Ω
Output Power	3 Watts (High) 250 Milliwatts (Low)
Battery Types	8 - "C" Duracell alkaline batteries
Battery Life	greater than 30 hours*
Dimensions	8.4" x 5.57" x 2.6"
Weight	2.2 lbs (2.8kg)

*depending on load, frequency and power setting

POWERED BY

RYCOM
 instruments, inc.

RECEIVER

Operating Frequency	200Hz - 480kHz • 50Hz 60Hz • RF
Antenna Mode	Null (vertical coil) • Peak (horizontal coil)
Audio Indication	Variable pitch audio
Operating Temperature	-4°F to 133° (-20°C to +55°C)
Battery Type	6 - "C" Duracell alkaline batteries
Battery Life	40 hours 82 hours (10 minute auto shut off)
Continuous	
Intermittent	
Dimensions	30.3" x 3.75" x 9.4"
Weight	3 pounds
Signal Strength	LCD bar graph Absolute Signal Strength readout 0-999
Gain Control	up/down button for automatic centering and manual control
Dynamic Range	126 dB
Depth Measurement	Digital depth readout to 25 feet (feet/ inches & metric)
Automatic	
Manual	Triangulation for verification of automatic readout in congested environments



The Rycom Model Key Tracker was designed for dependable operation without periodic adjustment and/or calibration. If, however, your Key Tracker is not working properly, return it to the factory for repair. A RMA (Return Material Authorization) is not required, but there is some necessary information needed to ensure your unit is repaired and returned properly. The required information may be obtained by phone, e-mail, fax or through our website.

Telephone: 816-353-2100 or 800-851-7347

Fax: 816-353-5050

E-mail: rycom@rycominstruments.com

Web: <http://www.rycominstruments.com/ServiceRMA.html>



Send it prepaid to:

Rycom Instruments, Inc.

9351 E. 59th Street

Raytown, MO 64133 U.S.A.

We will repair and ship the instrument back, or advise you if the instrument is unrepairable.

Note: There is a minimum charge for repair and handling.

When shipping your instrument, be sure to include:

1. The name, address, and phone number of your contact.
2. A brief description of the trouble.
3. A return shipping address & billing mail address & any special shipping instructions.

Packing Instructions:

Remove and discard all batteries. Place the unit to be repaired in the original shipping carton, or equivalent sturdy container. Add packing material around all sides of the unit. Seal the shipping container with strong tape. Failure to package the equipment properly may result in voiding warranty. Mark the shipping container:

FRAGILE ELECTRONIC EQUIPMENT

WARRANTY

This instrument is under warranty for one year from the date of delivery against defects in material and workmanship (**EXCEPT BATTERIES**). We will repair or replace products that prove to be defective during warranty period.

This warranty is void if, after having received the instrument in good condition, it is subjected to abuse, unauthorized alterations or casual repair.

No other warranty is expressed or implied. The warranty described in this paragraph shall be in lieu of any other warranty, including but not limited to, any implied warranty of merchantability or fitness for a particular purpose. We are not liable for consequential damages.





KEY TRACKER®



KEY | **KEY**
EQUIPMENT®
& SUPPLY CO.

SALES | RENTALS | SERVICE | PARTS

QR | **Quality**
RENTS®

KANSAS CITY
6716 Berger Avenue
Kansas City, KS 66111
800.262.0149

ST. LOUIS
13507 NW Industrial Dr.
Bridgeton, MO 63044
800.325.4323

keyequipment.com

qualityrentsequipment.com