

THE INDUSTRY'S MOST POWERFUL & DURABLE SEWER TOOLS



WARTHOG
SEWER NOZZLES BY **STONEAGE**®



PRODUCT CATALOG

2025

YOUR WORK IS VITAL

Every job you face is unique, with its own set of unpredictable challenges. From roots to wipes to something entirely new, you're under pressure to not just find and clear obstructions effectively, but ultimately to keep the public safe and healthy.

Luckily, Warthog's Authorized Dealers understand the challenges you face on a daily basis.

As members of your community, our dealers are eager to ensure you have the right nozzles on hand and ongoing expert support to help you get the job done as effectively as possible.



OUR DEALERS ARE **YOUR PARTNERS**

All Authorized Warthog Dealers are skilled professionals who understand your business. When it comes to the service and support you need to get the job done, they've got your back.

Our Dealers are trained and knowledgeable about Warthog products and can advise you on their best use and optimal maintenance for performance and durability.



SCAN HERE OR VISIT **WWW.WARTHOG-NOZZLES.COM/LOCATIONFINDER**
FOR A LIST OF AUTHORIZED DEALERS IN YOUR AREA

WHY CHOOSE **WARTHOG™**

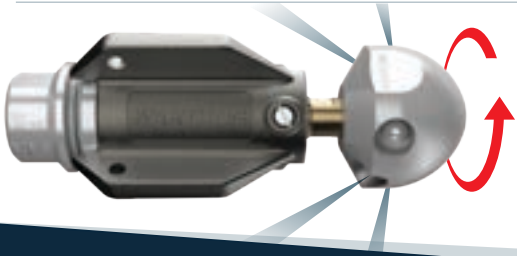

Warthog pioneered controlled rotation in the sewer market to ensure water hits 360° of the pipe interior at a speed that delivers the most effective cleaning.

WHY CONTROLLED ROTATION?

Fixed jets do not hit the whole pipe surface, leaving “stripes.” **Only rotating nozzles reliably clean the entire inner surface of the pipe.**

Warthog nozzles use a fluid braking system to slow nozzle rotation so that the jets have sufficient dwell time to penetrate and break up deposits. Controlled rotation provides powerful cleaning for pipe interiors in addition to clearing obstructions of all kinds: hair, roots, organic deposits, fats, oils, and grease.

POWER WHERE YOU NEED IT

JET ANGLES

CLEANING

Side jets are angled directly at the walls to cut through hard deposits

STANDARD

Jets thrust the tool forward while concurrently cleaning the surface

PULLING/FLUSHING

Powerful rear jets propel the tool down the line and flush out debris

TOOL CONFIGURATION

Warthog sewer nozzles are available in multiple configurations to deliver superior results for nearly any job. Our Authorized Warthog Dealers can precisely configure tools to send more power to cleaning, standard, or pulling/flushing jets to accommodate your specific cleaning needs.

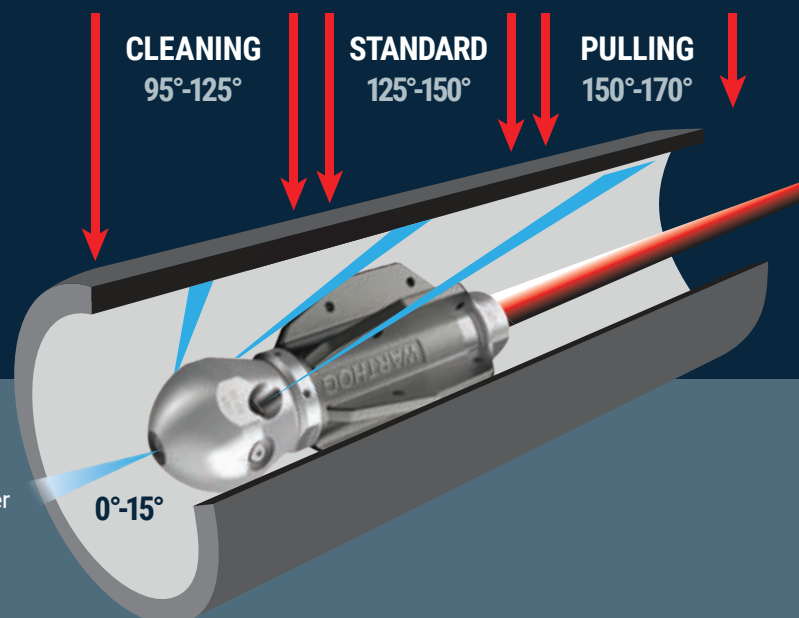



2025
SEWER TOOLS CHART



<i>PIPE</i>	<i>BODY</i>	<i>PAGE</i>
2-4"	<i>WV</i>	7
3-6"	<i>WT</i>	11
3-8"	<i>WX</i>	15
4-8"	<i>WS</i>	19
6-18"	<i>WH</i>	23
	<i>WHR</i> <i>MAGNUM</i>	29
	<i>WG</i>	35
8-36"	<i>WGR</i> <i>MAGNUM</i>	41

	HEAD	INLET	PRESSURE	FLOW	JET ANGLES	WEIGHT	SIZE	SERVICE
	STANDARD	1/4" NPT	1200-5000 psi	2.9-8.1 gpm	1 Front @ 15° 2 Rear @ 135°	0.4 lbs	1.5" D 2" L	N/A
	STANDARD	3/8" NPT & 1/2" NPT	1200-5000 psi	5-12 gpm (3/8")	1 Front @ 15° 2 Rear @ 150°	1.2 lbs	1.9" D 3" L	50 hours
				9-21 gpm (1/2")			1.9" D 3.4" L	
	DESCALER	3/8" NPT & 1/2" NPT	1200-5000 psi	9-15 gpm (3/8") 9-24 gpm (1/2")	1 Front @ 15° 2 Side @ 100° 2 Rear @ 170°	1.7 lbs	1.9" D 3.4" L	250 hours
	STANDARD	1/2" NPT	1200-5000 psi	9-21 gpm	1 Front @ 15° 2 Rear @ 150°	2.2lbs	2" D 5.5" L	50 hours
	STANDARD	1/2" NPT & 3/4"NPT	1200-8000 psi	10-35 gpm (1/2") 10-50 gpm (3/4")	1 Front @ 15° 2 Rear @ 150°	4.4 lbs	3.5" D 7.5" L	60 hours
	DESCALER				1 Front @ 15° 2 Side @ 105° 2 Rear @ 150°			
	PULLER DESCALER				3/4" NPT			
	DESCALER	3/4" NPT & 1" NPT	1200-8000 psi	20-50 gpm (1/2") 20-70 gpm (3/4")	1 Front @ 15° 2 Side @ 125° 2 Rear @ 152°	6.8 lbs	3.6" D 7.3" L	1600 hours
	HYBRID SWITCHER			20-50 gpm (1/2") 20-60 gpm (3/4")	CLEAN PULL 2 Side @ 100° 2 Rear @ 125°	8.8 lbs	3.6" D 8.9" L	
	STANDARD	1" NPT	1200-5000 psi	50-80 gpm	1 Front @ 15° 4 Rear @ 142°	9.2 lbs	5" D 9" L	60 hours
	DESCALER				1 Front @ 15° 2 Side @ 100° 4 Rear @ 142°			
	PULLER DESCALER				1 Front @ 15° 2 Side @ 100° 4 Rear @ 155°			
	DESCALER	1" NPT & 1 1/4" NPT	1200-5000 psi	50-90 gpm (1") 50-120 gpm (1 1/4")	1 Front @ 15° 2 Side @ 100° 4 Rear @ 142°	13 lbs	4.5" D 10.3" L	1600 hours
	PULLER DESCALER				1 Front @ 15° 2 Side @ 100° 4 Rear @ 155°			
	ROOT DESTROYER				1 Front @ 15° 8 Rear @ 135°			
	ROOT DESTROYER PULLER				1 Front @ 15° 2 Side @ 100° 2 Rear @ 149° 2 Rear @ 152° 2 Rear @ 155°			
	SWITCHER			50-80 gpm (1") 50-100 gpm (1 1/4")	CLEAN PULL 1 Front @ 15° 4 Rear @ 155° 2 Side @ 100° 2 Rear @ 125°	14 lbs	4.5" D 11.2" L	

WV



PIPE SIZE: **2-4"**
INLET: **1/4" NPT**
PRESSURE RATING: **1200-5000 psi**
FLOW RATE: **2.9-8.1 gpm**

IDEAL FOR: Cleaning and removing grease and ice from 2-4" pipes in restaurants, apartment complexes and residences. Delivers great results in small pipes with bends, including 90-degree elbows in 4" pipes.



- ➔ Maneuverable in lines as small as 2"
- ➔ Low maintenance thanks to seal-free, water bearing design
- ➔ Jetted for an equal balance of pulling/flushing & cleaning/cutting
- ➔ Head features a unique locking mechanism for added safety



STANDARD

JET ANGLES

Front: 1 @ 15°
Rear: 2 @ 135°

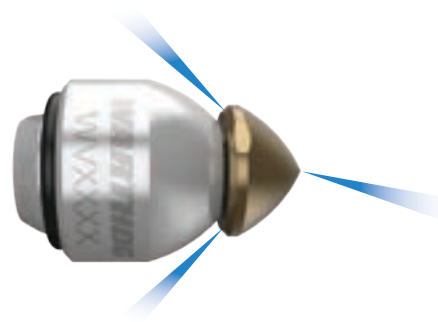

INLET	PART	PRESSURE RANGE	FLOW RANGE	FRONT PORT ANGLES	REAR PORT ANGLES	WEIGHT	DIAMETER X LENGTH
1/4"	WV-1/4-LK-A	1200-5000 psi	6.3-8.1 gpm	1 @ 15°	2 @ 135°	0.4 lbs	1.5" x 2"
	WV-1/4-LK-B		4.8-6.3 gpm				
	WV-1/4-LK-C		3.8-4.8 gpm				
	WV-1/4-LK-D		2.9-3.8 gpm				

When ordering any Warthog nozzle, please provide pump-specific pressure, flow, and hose length.

WHY CHOOSE THE **WV** CLASSIC

WV 2-4"

WT 3-6"

WX 3-8"

WS 4-8"

WH 6-18"

WG 8-36"

CENTRALIZERS

RESOURCES

The Warthog WV easily navigates elbows and bends to clear obstructions and polish pipe walls. WV nozzles require minimal maintenance thanks to the seal-free, bearing-free design.

GET THE MOST FROM YOUR WV

- ➔ Flush hoses before use to keep debris from entering the tool and preventing it from rotating
- ➔ Head can be replaced when worn to keep the tool operating at peak performance

EASY MAINTENANCE

Overhaul Kit

The WV Overhaul kit is designed to completely rebuild the tool with ease.

Tool Kit

Tool kits include the necessary tools required to replace the head on your WV nozzle.



WV 612-LK HEAD REPLACEMENT TOOL KIT

NEED HELP? CONTACT YOUR DEALER TODAY!

WT



PIPE SIZE: **3-6"**
INLET: **3/8" & 1/2" NPT**
PRESSURE RATING: **1200-5000 psi**
FLOW RATE: **5-21 gpm**
SERVICE INTERVAL: **50 Hours**

IDEAL FOR: Small capacity pumps and cart jettors, most commonly used on laterals at homes, buildings, restaurants and other light commercial facilities.

WV 2-4"

WT 3-6"

WX 3-8"

WS 4-8"

WH 6-18"

WG 8-36"

CENTRALIZERS

RESOURCES



- ➔ Designed to navigate multiple elbows and bends in pipes without getting hung up
- ➔ Tackles roots, ice, debris, buildup, and more
- ➔ Field serviceable and fully rebuildable



Actual Tool Size

STANDARD

JET ANGLES

Front: 1 @ 15°
Rear: 2 @ 150°

CLEANING

PULLING/
FLUSHING

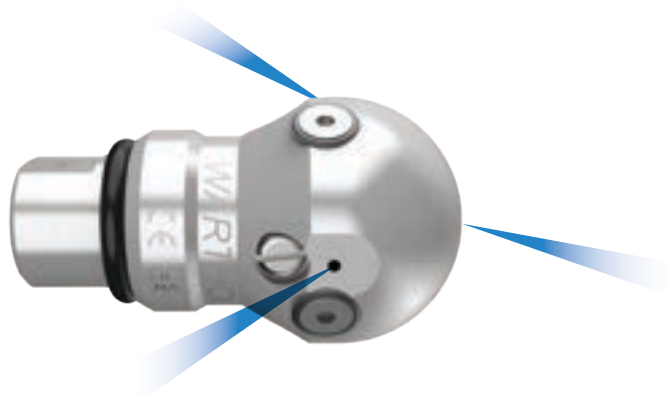

INLET	PART	PRESSURE RANGE	FLOW RANGE	FRONT PORT ANGLES	REAR PORT ANGLES	WEIGHT	DIAMETER X LENGTH
3/8"	WT-3/8-STD-PKG	1200-5000 psi	5-12 gpm	1 @ 15°	2 @ 150°	1.2 lbs	1.9" x 3"
1/2"	WT-1/2-STD-PKG		9-21 gpm				1.9" x 3.4"

When ordering any Warthog nozzle, please provide pump-specific pressure, flow, and hose length.

WHY CHOOSE THE **WT** CLASSIC

WW 2-4"

WT 3-6"

WX 3-8"

WS 4-8"

WH 6-18"

WG 8-36"

CENTRALIZERS

RESOURCES

The Warthog WT has a round body design to easily maneuver multiple bends, elbows, wyes, or sweeps without getting stuck— even in settled pipe.

GET THE MOST FROM YOUR **WT**

- ➔ Maintain optimal rotation speed by flushing Slow Viscous Fluid every 50 hours of use
- ➔ Keep debris from clogging the tool and preventing rotation by flushing hoses before use
- ➔ For safety, use WT with rigid stinger 1.5 times the diameter of the pipe to prevent turnaround

EASY MAINTENANCE

Service & Visc Kits

Service kits are designed to replace wearable components and the viscous fluid to keep the tool working optimally.

Overhaul Kits

Overhaul kits are designed to completely rebuild a tool.

Tool Kits

Tool kits include the necessary tools required to maintain your Warthog nozzle.



WJK



PIPE SIZE: **3-8"**

INLET: **3/8" & 1/2" NPT**

PRESSURE RATING: **1200-5000 psi**

FLOW RATE: **9-24 gpm**

SERVICE INTERVAL: **250 Hours**

IDEAL FOR: Maximum descaling and flushing power while maneuvering multiple bends, long-radius elbows, wyes, or sweeps without hang-ups in offsets, fractures, or settled pipe.

WV 2-4"

WT 3-6"

WX 3-8"

WS 4-8"

WH 6-18"

WG 8-36"

CENTRALIZERS

RESOURCES



- ⊕ Two fixed low angle back jets for max thrust and flushing
- ⊕ Additional controlled rotary jets in the head configuration
- ⊕ Minimum pressure loss through the tool, delivering more power to the nozzles for higher jet impact



Actual Tool Size

DESCALER

JET ANGLES

Front: 1 @ 15°
Side: 2 @ 100°
Rear: 2 @ 170°

CLEANING

PULLING/
FLUSHING

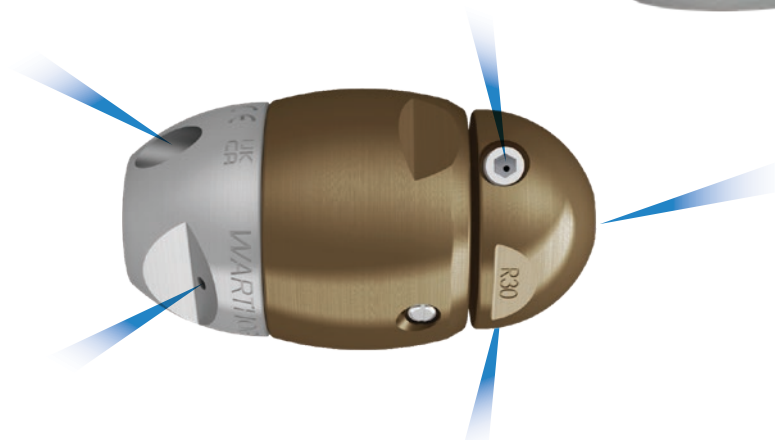

INLET	PART	PRESSURE RANGE	FLOW RANGE	FRONT PORT ANGLES	SIDE PORT ANGLES	REAR PORT ANGLES	WEIGHT	DIAMETER X LENGTH
3/8"	WTA-3/8-PKG	1200-5000 psi	9-15 gpm	1 @ 15°	2 @ 100°	2 @ 170°	1.7 lbs	1.9" x 3.4"
1/2"	WTA-1/2-PKG (No Whip Hose) WTA-H-PKG (with Whip Hose)		9-24 gpm					

When ordering any Warthog nozzle, please provide pump-specific pressure, flow, and hose length.



STANDARD WHIP HOSE AVAILABLE FOR 1/2" INLET
The whip hose reduces wear on the pressure hose.

WHY CHOOSE THE **WX**

A compact powerhouse nozzle that easily maneuvers long radius elbows in 3-8" pipes. Combining the power of the WS and the maneuverability of the WT, the WX boasts the longest service life of all the small pump Warthog nozzles (250 hours).

GET THE MOST FROM YOUR **WX**

- ➔ Adjustable jet sizes can focus the flow on pulling or towards descaling and cutting
- ➔ Viscous fluid ports simplify field maintenance
- ➔ Elliptical body design allows the tool to easily maneuver long radius elbows

EASY MAINTENANCE

Service & Visc Kits

Service kits are designed to replace wearable components and the viscous fluid to keep the tool working optimally.

Overhaul Kits

Overhaul kits are designed to completely rebuild a tool.

Tool Kits

Tool kits include the necessary tools required to maintain your Warthog nozzle.



WX 610-ST1 OVERHAUL /REPAIR KIT



WV 2-4"

WT 3-6"

WX 3-8"

WS 4-8"

WH 6-18"

WG 8-36"

CENTRALIZERS

RESOURCES

WS





PIPE SIZE: **4-8"**
INLET: **1/2" NPT**
PRESSURE RATING: **1200-5000 psi**
FLOW RATE: **9-21 gpm**
SERVICE INTERVAL: **50 Hours**

IDEAL FOR: Plumbing professionals using trailer jetters to clean pipes in restaurants, hospitals, multi-story apartment buildings, residential, and other applications.

WV 2-4"

WT 3-6"

WX 3-8"

WS 4-8"

WH 6-18"

WG 8-36"

CENTRALIZERS

RESOURCES



- ⊕ Jetted for an equal balance of pulling/flushing & cleaning/cutting
- ⊕ Compact and highly maneuverable
- ⊕ Optional whip hose to reduce wear on the pressure hose



Actual Tool Size

STANDARD

JET ANGLES

Front: 1 @ 15°
Rear: 2 @ 150°

CLEANING

PULLING/
FLUSHING



INLET	PART	PRESSURE RANGE	FLOW RANGE	FRONT PORT ANGLES	REAR PORT ANGLES	WEIGHT	DIAMETER X LENGTH
1/2"	WS-NH-1/2-PKG (No Whip Hose)	1200-5000 psi	9-21 gpm	1 @ 15°	2 @ 150°	2.2 lbs	2" x 5.5"
	WS-H-1/2-PKG (With Whip Hose)						

When ordering any Warthog nozzle, please provide pump-specific pressure, flow, and hose length.



STANDARD WHIP HOSE OPTION

The whip hose reduces wear on the pressure hose.

WHY CHOOSE THE **WS** CLASSIC

WV 2-4"

WT 3-6"

WX 3-8"

WS 4-8"

WH 6-18"

WG 8-36"

CENTRALIZERS

RESOURCES

An industry favorite, this versatile nozzle easily clears grease, roots, ice, and soil blockages from 4-8" pipes.

GET THE MOST FROM YOUR **WS**

- ⊕ The replaceable whip hose reduces wear on the larger pressure hose, saving on hefty hose replacement costs
- ⊕ The rigid inlet (no whip hose) option is ideal for straight pipes
- ⊕ Extend tool life by using compressed air to blow out all water before storing tool

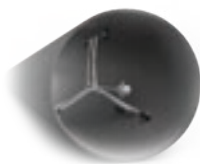

Need to add a centralizer?

See **CENTRALIZERS** on Page 48-49

EASY MAINTENANCE

Service & Visc Kits

Service kits are designed to replace wearable components and the viscous fluid to keep the tool working optimally.

Overhaul Kits

Overhaul kits are designed to completely rebuild a tool.

Tool Kits

Tool kits include the necessary tools required to maintain your Warthog nozzle.



WS 610-RT1 OVERHAUL/REPAIR KIT

**TOOL
MANUAL**



WH CLASSIC





PIPE SIZE: **6-18"**
INLET: **1/2" & 3/4" NPT**
PRESSURE RATING: **1200-8000 psi**
FLOW RATE: **10-50 gpm**
SERVICE INTERVAL: **60 Hours**

IDEAL FOR: Municipal and industrial sewer cleaning professionals and large combination trucks to clear lines from 6-18"

WV 2-4"

WT 3-6"

WX 3-8"

WS 4-8"

WH 6-18"

WG 8-36"

CENTRALIZERS

RESOURCES



- ➔ Delivers quality results with the most common equipment setups
- ➔ Repairable, rebuildable, and field serviceable
- ➔ Cast unibody centralizer boosts durability

MULTIPLE HEAD OPTIONS

See **SPECIFICATIONS** on
the following page



Actual Tool Size

WHY CHOOSE THE **WH** CLASSIC

WW 2-4"

WT 3-6"

WX 3-8"

WS 4-8"

WH 6-18"

WG 8-36"

CENTRALIZERS

RESOURCES

The WH delivers consistent, exceptional results with the most common equipment setups, with multiple head options for a customized approach to each application. Controlled rotation technology allows the WH's jets to deeply penetrate through the toughest deposits and blockages.

GET THE MOST FROM YOUR **WH**

- ➔ Interchangeable head options for jobs requiring extra descaling or flushing power
- ➔ Optimal for small capacity combination jetters and large trailer jetters with a capacity of 50GPM or less



Need to add a centralizer?

See **CENTRALIZERS** on Page 48-49

EASY MAINTENANCE

Service & Visc Kits

Service kits are designed to replace wearable components and the viscous fluid to keep the tool working optimally.

Overhaul Kits

Overhaul kits are designed to completely rebuild a tool.

Tool Kits

Tool kits include the necessary tools required to maintain your Warthog nozzle.



WH CLASSIC

STANDARD

JET ANGLES

Front: 1 @ 15°
Rear: 2 @ 150°



Jetted for an equal balance of pulling/flushing & cleaning/cutting

INLET	PART	PRESSURE RANGE	FLOW RANGE	FRONT PORT ANGLES	REAR PORT ANGLES	WEIGHT	DIAMETER X LENGTH
1/2"	WH-1/2-PKG	1200-8000 psi	10-35 gpm	1 @ 15°	2 @ 150°	4.4 lbs	3.5" x 7.5"
3/4"	WH-3/4-PKG		10-50 gpm				

DESCALER

JET ANGLES

Front: 1 @ 15°
Side: 2 @ 105°
Rear: 2 @ 150°



Two side jets are angled to reduce stand-off distance to the pipe wall, delivering intense jet impact to remove tough buildup, calcium deposits, and scaling with ease, resulting in a faster clean time

Jetting is configured with more force to the side jets for cleaning and polishing

INLET	PART	PRESSURE RANGE	FLOW RANGE	FRONT PORT ANGLES	SIDE PORT ANGLES	REAR PORT ANGLES	WEIGHT	DIAMETER X LENGTH
1/2"	WH-1/2-DS-PKG	1200-8000 psi	10-35 gpm	1 @ 15°	2 @ 105°	2 @ 150°	4.4 lbs	3.5" x 7.5"
3/4"	WH-3/4-DS-PKG		10-50 gpm					

PULLER DESCALER

JET ANGLES

Front: 1 @ 15°
 Side: 2 @ 105°
 Rear: 2 @ 162°



Jetting is configured with more force to the side jets for cleaning and polishing and to the rear jets for extra pulling power

Side jets are angled to reduce stand-off distance to the pipe wall, delivering intense jet impact to remove tough buildup, calcium deposits, and scaling with ease

Rear jets are angled further back to increase pulling power for long runs and climbs, and max flushing capability

INLET	PART	PRESSURE RANGE	FLOW RANGE	FRONT PORT ANGLES	SIDE PORT ANGLES	REAR PORT ANGLES	WEIGHT	DIAMETER X LENGTH
3/4"	WH-3/4-PDS-PKG	1200-8000 psi	10-50 gpm	1 @ 15°	2 @ 105°	2 @ 162°	4.4 lbs	3.5" x 7.5"



Using **RECYCLED WATER?**
 See the WHR Magnum on the next page

WV 2-4"

WT 3-6"

WX 3-8"

WS 4-8"

WH 6-18"

WG 8-36"

CENTRALIZERS

RESOURCES

SELECT DEALERS

WHR MAGNUM





PIPE SIZE: **6-18"**
INLET: **3/4" & 1" NPT**
PRESSURE RATING: **1200-8000 psi**
FLOW RATE: **20-70 gpm**
SERVICE INTERVAL: **1600 Hours**

IDEAL FOR: IDEAL FOR: Municipal and industrial sewer cleaning professionals running large combination trucks who need extended service life and maximum cleaning power.

WH 6-18"

WG 8-36"

CENTRALIZERS

RESOURCES

WS 4-8"

WX 3-8"

WT 3-6"

WV 2-4"

SELECT DEALERS

WHR MAGNUM

TOOL
RESOURCES



- ➔ Effortlessly clears tough obstructions and heavy debris in large-diameter pipes
- ➔ Engineered for extended service life in the toughest conditions, up to 1600 hours
- ➔ 6-fin cast unibody allows for steeper rear jets to perform maximum pulling/flushing

MULTIPLE HEAD OPTIONS

See **SPECIFICATIONS** on
the following page



Actual Tool Size

WHY CHOOSE THE **WHR** MAGNUM

WV 2-4"
WT 3-6"
WX 3-8"
WS 4-8"
WH 6-18"
WG 8-36"
CENTRALIZERS
RESOURCES

The WHR Magnum is designed to clean and clear municipal and industrial pipes between 6-18". Built for maximum durability and performance, it clears tough obstructions, buildup, and heavy debris. Its powerful cleaning performance tackles jobs quickly and efficiently, using less water and fuel so you can save resources and move on to your next project even faster.

GET THE MOST FROM YOUR **WHR** MAGNUM

- ➔ Handles recycled water effectively
- ➔ Access ports enable viscous fluid change without disassembly for easy field maintenance
- ➔ Customizable rotation speed via viscous fluid options

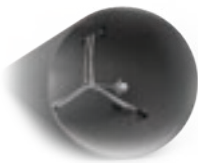

Need to add a centralizer?

See **CENTRALIZERS** on Page 48-49

EASY MAINTENANCE

Service & Visc Kits

Service kits are designed to replace wearable components and the viscous fluid to keep the tool working optimally.

Overhaul Kits

Overhaul kits are designed to completely rebuild a tool.

Tool Kits

Tool kits include the necessary tools required to maintain your Warthog nozzle.



WHR-U 610-RT1 OVERHAUL/REPAIR KIT

**TOOL
MANUAL**



SELECT DEALERS

WHR MAGNUM

DESCALER

JET ANGLES

Front: 1 @ 15°
 Side: 2 @ 125°
 Rear: 2 @ 152°



Side jets are angled to reduce stand-off distance to the pipe wall, delivering intense jet impact to quickly remove tough buildup, calcium deposits, and scaling with ease

Jetting is configured with more force to the side jets for stronger cleaning and polishing

INLET	PART	PRESSURE RANGE	FLOW RANGE	FRONT PORT ANGLES	SIDE PORT ANGLES	REAR PORT ANGLES	WEIGHT	DIAMETER X LENGTH
3/4"	WHR-U-3/4-DS-PKG	1200-8000 psi	20-50 gpm	1 @ 15°	2 @ 125°	2 @ 152°	6.8 lbs	3.6" x 7.3"
1"	WHR-U-1-DS-PKG		20-70 gpm					

HYBRID SWITCHER

JET ANGLES

PULLING MODE **CLEANING MODE**
 Front: 1 @ 15° Side: 2 @ 100°
 Rear: 4 @ 155° Rear: 2 @ 125°

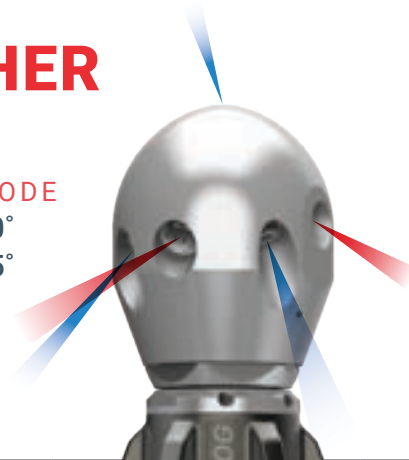

Jetting is configured to send full flow to the front and side jets for cleaning OR to the rear jets for pulling and flushing

The operator controls which set of jets get water flow while the tool is in the pipe

One nozzle with two sets of jets - turn on pulling jets to run down the pipe, switch to descaling jets to clean and unplug

INLET	PART	PRESSURE RANGE	FLOW RANGE	FRONT PORT ANGLES	SIDE PORT ANGLES	REAR PORT ANGLES	WEIGHT	DIAMETER X LENGTH
3/4"	WHR-U-3/4-SWT-HYBRID-PKG	1200-8000 psi	20-50 gpm	1 @ 15°	2 @ 100°	4 @ 155°	8.8 lbs	3.6" x 8.9"
1"	WHR-U-3/4-SWT-HYBRID-PKG		20-60 gpm			2 @ 125°		

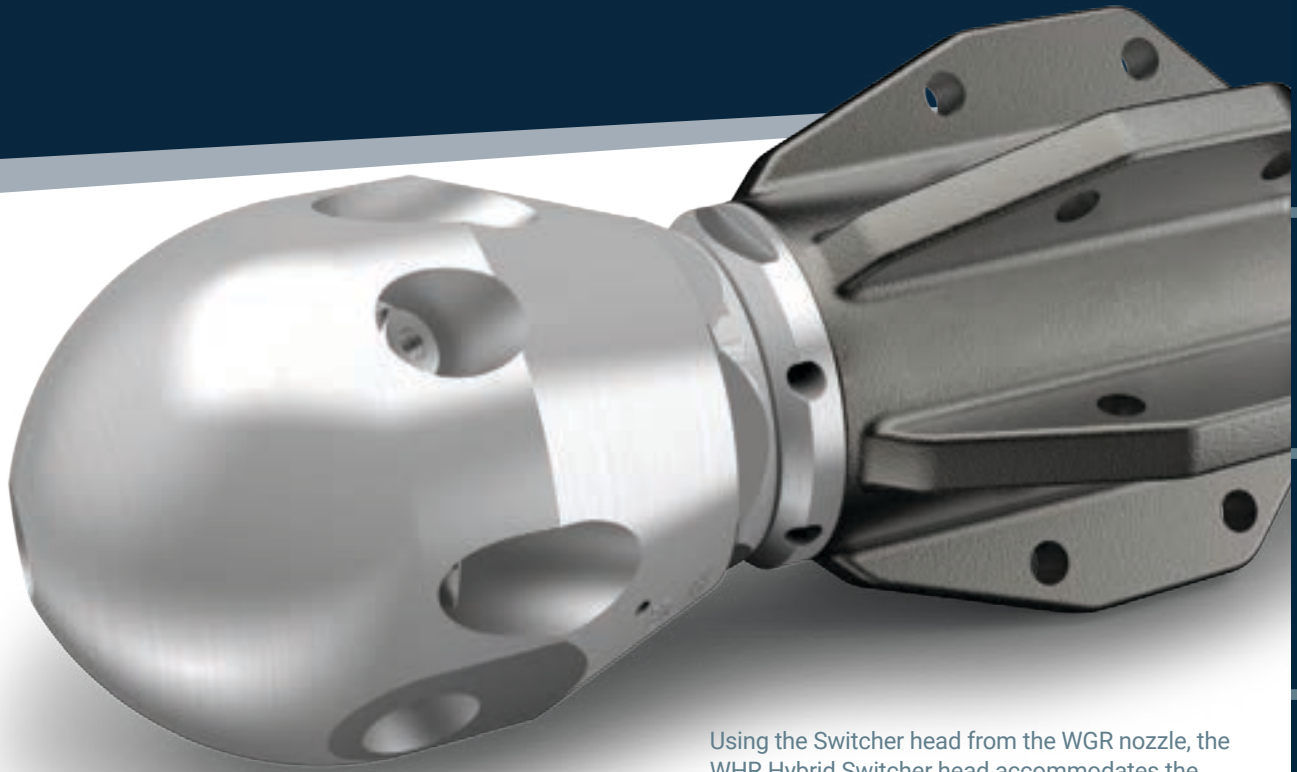

Using the Switcher head from the WGR nozzle, the WHR Hybrid Switcher head accommodates the higher flow of the larger hose, while keeping the maneuverability of the smaller tool size.

SWITCHER™

SEE IT
IN ACTION



Maximum pulling and maximum cleaning without leaving the pipe.

Switcher technology allows a nozzle operator to direct full jet power to **EITHER** the rear jets for maximum thrust **OR** the side jets for maximum cleaning while the tool is inside the pipe.

- ⊕ Save time and money with less water and half the runs
- ⊕ Full power pulling/flushing and full power cleaning/descaling in one nozzle
- ⊕ Available in WHR and WGR models for cleaning sewer pipes from 6-36"

See **Page 47** to learn more

WV 2-4"

WT 3-6"

WX 3-8"

WS 4-8"

WH 6-18"

WG 8-36"

CENTRALIZERS

RESOURCES

WVG CLASSIC





PIPE SIZE: **8-36"**
INLET: **1" NPT**
PRESSURE RATING: **1200-5000 psi**
FLOW RATE: **50-80 gpm**
SERVICE INTERVAL: **60 Hours**

IDEAL FOR: Municipal and industrial sewer cleaning professionals running large combination trucks with 1" hose.

WV 2-4"

WT 3-6"

WX 3-8"

WS 4-8"

WH 6-18"

WG 8-36"

CENTRALIZERS

RESOURCES

TOOL
RESOURCES



- ➔ Precision-controlled rotation ensures thorough removal of grease, scale, roots, and debris
- ➔ Optimized design minimizes downtime and delivers consistent, exceptional results
- ➔ Reliability and consistent performance in demanding pipe-cleaning applications

MULTIPLE HEAD OPTIONS

See **SPECIFICATIONS** on
the following page



Actual Tool Size

WHY CHOOSE THE **WG** CLASSIC

The WG Classic is the industry standard for powerful and efficient pipe cleaning. Engineered for reliability and superior performance, it delivers unparalleled cleaning results while reducing operating costs. It is built to handle grease, scale, roots, and debris with precision-controlled rotation and rugged durability, boosting productivity while reducing downtime.

GET THE MOST FROM YOUR **WG**

- ➔ Repairable, rebuildable, and field serviceable
- ➔ Interchangeable head options for jobs requiring extra descaling or flushing power

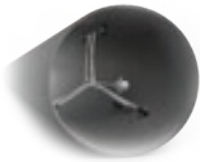

Need to add a centralizer?

See **CENTRALIZERS** on Page 48-49

EASY MAINTENANCE

Service & Visc Kits

Service kits are designed to replace wearable components and the viscous fluid to keep the tool working optimally.

Overhaul Kits

Overhaul kits are designed to completely rebuild a tool.

Tool Kits

Tool kits include the necessary tools required to maintain your Warthog nozzle.



WG 610 RT-1 OVERHAUL KIT

**TOOL
MANUAL**



WV 2-4"

WT 3-6"

WX 3-8"

WS 4-8"

WH 6-18"

WG 8-36"

CENTRALIZERS

RESOURCES

STANDARD

JET ANGLES

Front: 1 @ 15°
Rear: 4 @ 142°



Jetted for an equal balance of pulling/flushing & cleaning/cutting

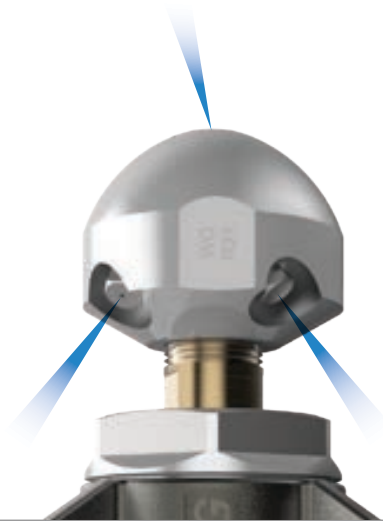

INLET	PART	PRESSURE RANGE	FLOW RANGE	FRONT PORT ANGLES	REAR PORT ANGLES	WEIGHT	DIAMETER X LENGTH
1"	WG-1-PKG	1200-5000 psi	50-80 gpm	1 @ 15°	4 @ 142°	9.2 lbs	5" x 9"

DESCALER

JET ANGLES

Front: 1 @ 15°
Side: 2 @ 100°
Rear: 4 @ 142°



Two side jets are angled to reduce stand-off distance to the pipe wall, delivering intense jet impact to remove tough buildup, calcium deposits, and scaling with ease, resulting in a faster clean time

Jetting is configured with more force to the side jets for cleaning and polishing



INLET	PART	PRESSURE RANGE	FLOW RANGE	FRONT PORT ANGLES	SIDE PORT ANGLES	REAR PORT ANGLES	WEIGHT	DIAMETER X LENGTH
1"	WG-1-DS-PKG	1200-5000 psi	50-80 gpm	1 @ 15°	2 @ 100°	4 @ 142°	9.6 lbs	5" x 9.5

PULLER DESCALER

JET ANGLES

Front: 1 @ 15°
 Side: 2 @ 100°
 Rear: 4 @ 155°



Jetting is configured with more force to the side jets for cleaning and polishing and to the rear jets for extra pulling power

Side jets are angled to reduce stand-off distance to the pipe wall, delivering intense jet impact to remove tough buildup, calcium deposits, and scaling with ease

Rear jets are angled further back to increase pulling power for long runs and climbs, and max flushing capability

INLET	PART	PRESSURE RANGE	FLOW RANGE	FRONT PORT ANGLES	SIDE PORT ANGLES	REAR PORT ANGLES	WEIGHT	DIAMETER X LENGTH
1"	WG-1-PDS-PKG	1200-5000 psi	50-80 gpm	1 @ 15°	2 @ 100°	4 @ 155°	9.6 lbs	5" x 9.5"



Using **RECYCLED WATER?**
 See the WGR Magnum on the next page

WV 2-4"

WT 3-6"

WX 3-8"

WS 4-8"

WH 6-18"

WG 8-36"

CENTRALIZERS

RESOURCES

SELECT DEALERS

WGR MAGNUM





PIPE SIZE: **8-36"**
INLET: **1" & 1 1/4" NPT**
PRESSURE RATING: **1200-5000 psi**
FLOW RATE: **50-120 gpm**
SERVICE INTERVAL: **1600 Hours**

IDEAL FOR: Municipal and industrial sewer cleaning professionals running large combination trucks with 1" & 1 1/4" hose.

WV 2-4"

WT 3-6"

WX 3-8"

WS 4-8"

WH 6-18"

WG 8-36"

CENTRALIZERS

RESOURCES

SELECT DEALERS

WGR MAGNUM

TOOL
RESOURCES



- ➔ Designed to handle 8-36" pipes
- ➔ Lower maintenance costs with superior components designed to withstand heavy use and reduce wear and tear
- ➔ High-efficiency cleaning reduces job completion time while reducing water and fuel usage

MULTIPLE HEAD OPTIONS

See **SPECIFICATIONS** on
the following pages



Actual Tool Size

WHY CHOOSE THE **WGR** MAGNUM

The WGR is the ultimate nozzle for efficient and thorough sewer cleaning in municipal, industrial, and residential sewer systems. Engineered with precision and durability, the WGR features revolutionary controlled rotation technology that delivers unmatched cleaning power to obliterate the toughest obstructions, grease, roots, buildup, and debris.

GET THE MOST FROM YOUR **WGR** MAGNUM

- ⊕ Handles recycled water effectively
- ⊕ Access ports enable viscous fluid change without disassembly for easy field maintenance
- ⊕ Customizable rotation speed via viscous fluid options

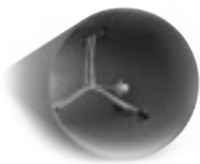

Need to add a centralizer?

See **CENTRALIZERS** on Page 48-49

EASY MAINTENANCE

Service & Visc Kits

Service kits are designed to replace wearable components and the viscous fluid to keep the tool working optimally.

Overhaul Kits

Overhaul kits are designed to completely rebuild a tool.

Tool Kits

Tool kits include the necessary tools required to maintain your Warthog nozzle.



WGR-U 600-ST-1 SERVICE KIT



WV 2-4"

WT 3-6"

WX 3-8"

WS 4-8"

WH 6-18"

WG 8-36"

CENTRALIZERS

RESOURCES

SELECT DEALERS

WGR MAGNUM

DESCALER

JET ANGLES

Front: 1 @ 15°
Side: 2 @ 100°
Rear: 4 or 6 @ 142°

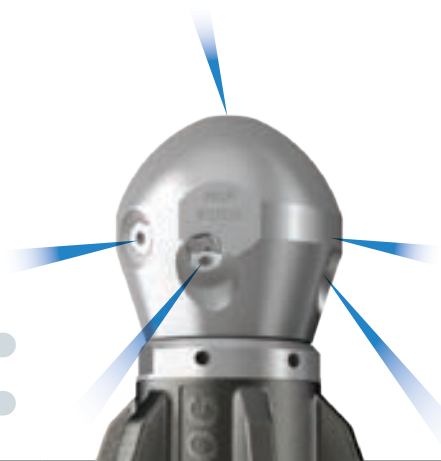

Side wall cleaning for calcium, grease and heavy deposits

Jets are angled to drive water under the debris to lift it in sheets and flush it away

Jetting is configured with more force to the side jets for cleaning and polishing

INLET	PART	PRESSURE RANGE	FLOW RANGE	FRONT PORT ANGLES	SIDE PORT ANGLES	BACK PORT ANGLES	WEIGHT	DIAMETER X LENGTH
1"	WGR-U-1-DS-PKG	1200-5000 psi	50-90 gpm	1 @ 15°	2 @ 100°	4 @ 142°	13 lbs	10.3" x 4.5"
1 1/4"	WGR-U-1-1/4-DS-PKG		50-120 gpm			6 @ 142°		

PULLER DESCALER

JET ANGLES

Front: 1 @ 15°
Side: 2 @ 100°
Rear: 4 @ 155°



Jetting is configured with more force to the side jets for cleaning and polishing and to the rear jets for extra pulling power

Side jets are angled to reduce standoff distance to the pipe wall, delivering intense jet impact to remove tough buildup, calcium deposits, and scaling with ease

Rear jets are angled further back to increase pulling power for long runs and climbs, and max flushing capability

INLET	PART	PRESSURE RANGE	FLOW RANGE	FRONT PORT ANGLES	SIDE PORT ANGLES	REAR PORT ANGLES	WEIGHT	DIAMETER X LENGTH
1"	WGR-U-1-PDS-PKG	1200-5000 psi	50-90 gpm	1 @ 15°	2 @ 100°	4 @ 155°	13 lbs	10.3" x 4.5"
1 1/4"	WGR-U-1-1/4-PDS-PKG		50-120 gpm					

ROOT DESTROYER

JET ANGLES

Front: 1 @ 15°
Rear: 8 @ 135°

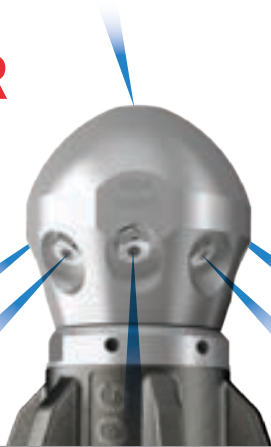

Jetting is configured to send max force to specially angled side jets optimized for root cutting

Eight powerful, in-line jets create a water blade proven to clear roots faster, saving time, water and money

Reduces the use of mechanical tools that can damage the pipe

INLET	PART	PRESSURE RANGE	FLOW RANGE	FRONT PORT ANGLES	REAR PORT ANGLES	WEIGHT	DIAMETER X LENGTH
1"	WGR-U-1-RD-PKG	1200-5000 psi	50-90 gpm	1 @ 15°	8 @ 135°	13 lbs	10.3" x 4.5"
1 1/4"	WGR-U-1-1/4-RD-PKG		50-120 gpm				

ROOT DESTROYER PULLER

JET ANGLES

Front: 1 @ 15°
Side: 2 @ 100°
Rear: 2 @ 150°, 2 @ 152°, 2 @ 155°

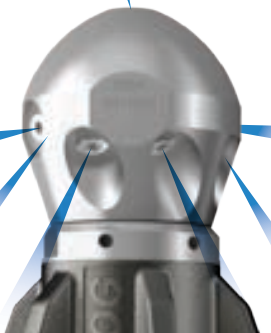

Adjusted jet angles for increased pulling power

Jetting is configured to send max force to precision angled side jets optimized for descaling and root cutting

Eight powerful jets: Two jets angled for maximum power to the side of the pipe and six jets in offset pairs to provide extra thrust for long pulls, uphill pulls, and heavier rodder hose

INLET	PART	PRESSURE RANGE	FLOW RANGE	FRONT PORT ANGLES	SIDE PORT ANGLES	REAR PORT ANGLES	WEIGHT	DIAMETER X LENGTH
1"	WGR-U-1-RDP-PKG	1200-5000 psi	50-90 gpm	1 @ 15°	2 @ 100°	2 @ 149°	13 lbs	10.3" x 4.5"
1 1/4"	WGR-U-1-1/4-RDP-PKG		50-120 gpm			2 @ 152°		
			2 @ 155°					

WV 2-4"

WT 3-6"

WX 3-8"

WS 4-8"

WH 6-18"

WG 8-36"

CENTRALIZERS

RESOURCES

SELECT DEALERS

WGR MAGNUM

SWITCHER

JET ANGLES

PULLING MODE

Front: 1 @ 15°

Rear: 4 @ 155°

CLEANING MODE

Side: 2 @ 100°

Rear: 2 @ 125°

CLEANING

PULLING/
FLUSHING

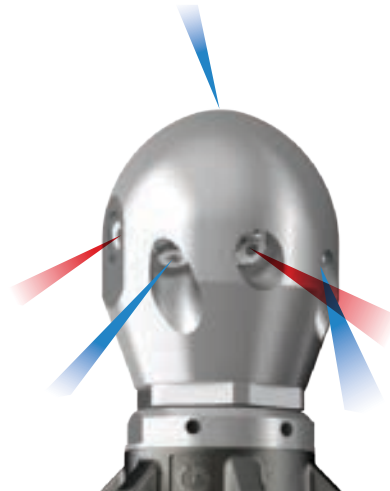

INLET	PART	PRESSURE RANGE	FLOW RANGE	FRONT PORT ANGLES	SIDE PORT ANGLES	REAR PORT ANGLES	WEIGHT	DIAMETER X LENGTH
1"	WGR-U-1-SWT-PKG	1200-5000 psi	50-80 gpm	1 @ 15°	2 @ 125°	4 @ 155° 2 @ 125°	14 lbs	11.2" x 4.5"
1 1/4"	WGR-U-1-1/4-SWT-PKG		50-100 gpm					

Switcher technology allows a nozzle operator to direct full jet power to **EITHER** the rear jets for maximum thrust **OR** the side jets for maximum descaling while the tool is inside the pipe.

- ⊕ Save time and money with less water and half the runs
- ⊕ Full power pulling/flushing and full power descaling in one nozzle
- ⊕ Available in WHR and WGR models for cleaning sewer pipes from 6-36"

“ For me, it's the versatility. It has the ability to cut roots in cleaning mode without blowing up the houses. It's also very important that it climbs hills very effectively – which it does. **It's revolutionary. There is no other product in the market today that will switch like that.**

-Jason Demartini – Vallejo Sanitation

SWITCHER™

THE ONLY NOZZLE OF ITS KIND IN THE INDUSTRY

Complete your job with half the runs, saving water, time, and money.



SEE IT IN ACTION

HOW DOES IT WORK?

Maximum pulling and maximum descaling without leaving the pipe.

De-pressurize and re-pressurize the pump to switch between modes and change jetting on the fly while the tool is in the pipe

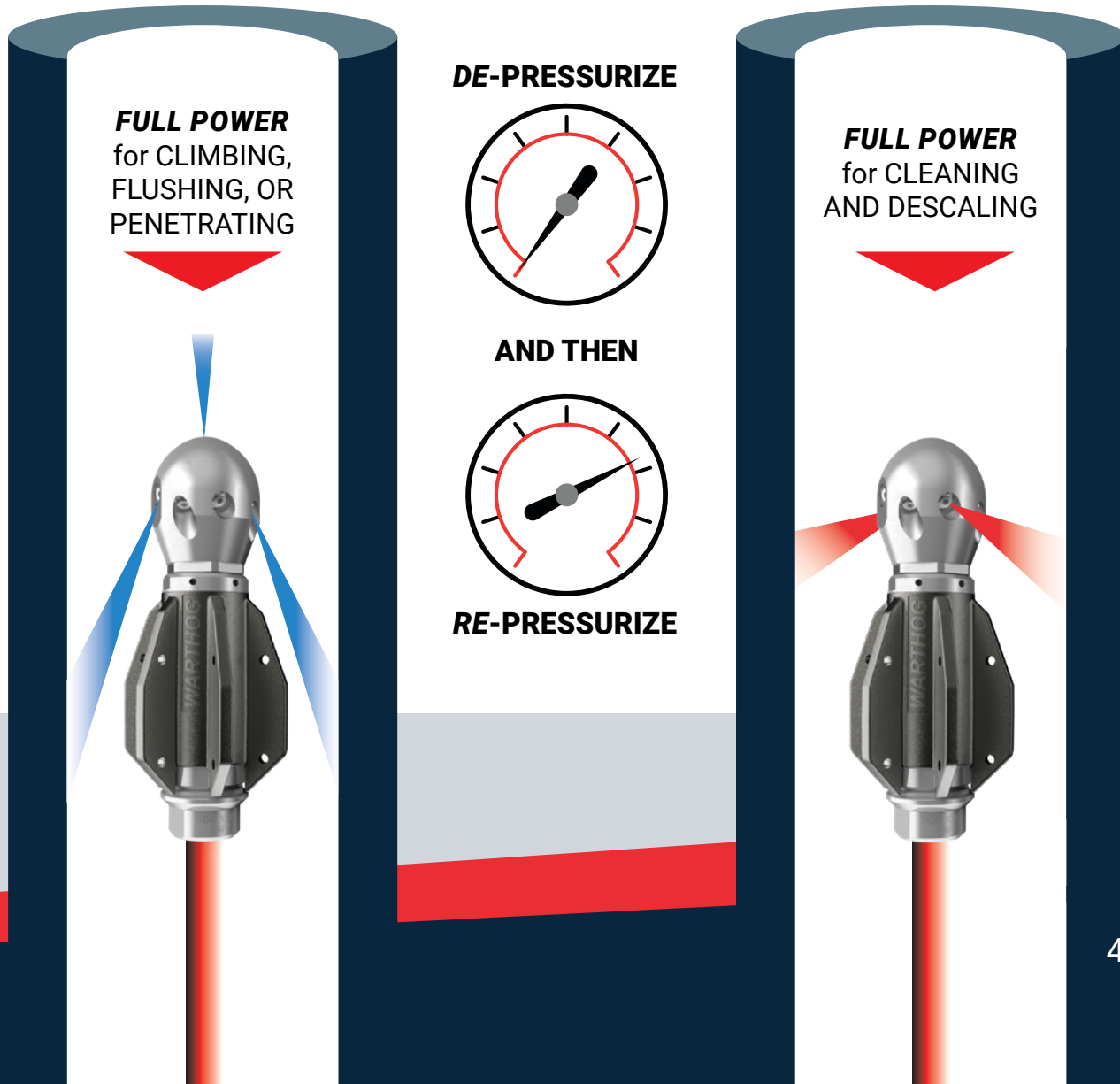

WV 2-4"

WT 3-6"

WX 3-8"

WS 4-8"

WH 6-18"

WG 8-36"

CENTRALIZERS

RESOURCES

CENTRALIZERS

A centralizer helps to protect the tool as it passes through the pipe and balances jet standoff distance for more consistent cleaning.

In cases where the pipe size is more than 1.5 times the tool diameter, a centralizer is an important safety device, preventing the tool from turning around and dangerously thrusting backwards out the pipe.

6-WHEEL ADJUSTABLE CENTRALIZER

Adjustable scissor style aluminium frame with tough plastic wheels. Easily converts to different pipe sizes.

INLET	PART	DIAMETER	PIPE
1"	WG 286-M-P16	13" - 36"	Straight pipes, Up to 5'

USE WITH: **WG** CLASSIC **WGR** MAGNUM



8-WHEEL ADJUSTABLE CENTRALIZER

Adjustable telescopic steel legs with tough plastic wheels. Easily converts to different pipe sizes.

INLET	PART	DIAMETER	PIPE
1"	WG 288-S-P16	16.5" - 22"	Pipes with bends, up to 36"

USE WITH: **WG** CLASSIC **WGR** MAGNUM

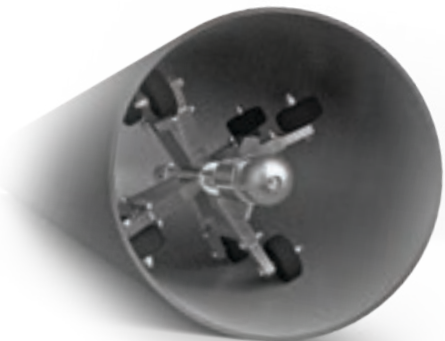

POLY-FIN CENTRALIZER

Interchangeable poly skids that bolt on to collars and change out easily. This skid navigates elbows and can effectively handle up to 12" diameter pipes

INLET	PART	DIAMETER	PIPE
N/A	WG 070-6	6"	Straight or bent pipes
	WG 070-8	8"	
	WG 070-10	10"	
	WG 070-12	12"	

USE WITH: **WG CLASSIC** **WGR MAGNUM**



SUPER CENTRALIZER

For multiple pipe sizes & tools

INLET	PART	DIAMETER	PIPE
N/A	WS 084	4.5"	Straight or bent, 5" min ID
	WH 085	5.5"	Straight or bent, 6" min ID
	WG 085	7"	Straight or bent, 8" min ID

USE WITH: **WS CLASSIC** **WH CLASSIC** **WHR MAGNUM** **WG CLASSIC** **WGR MAGNUM**



WE'VE GOT WHAT YOU NEED TO **STAY INFORMED**



VISIT OUR WEBSITE OR DOWNLOAD OUR MOBILE APP

Access our directory of Authorized Dealers and service center locations, product manuals and user instructions, along with a complete library of instructional videos

www.warthog-nozzles.com

USE OUR JETTING APP

Use our free calculators to evaluate your pressure, flow and jetting so you can dial in the best working configuration for your job

jetting.stoneagetools.com



CONNECT ON SOCIAL MEDIA

Join us on your favorite platforms for the latest products, industry news, tips and tricks and much more! **Tag us to be featured #WarthogNozzles**



THIS STARTED OUT AS **TWO GUYS IN A GARAGE**



StoneAge was launched in 1979 when co-founders John Wolgamott and Jerry Zink developed a new self-rotary waterjet nozzle in Jerry's garage. Originally intended for the mining industry "to cut holes in rock," the nozzles revolutionized the way tubes and pipes are cleaned. The founders' passion for research and development bred a culture of product innovation where the commitment to designing new tools and equipment has improved the way the waterblasting industry works for over 40 years. We are proud to be an employee-owned company focused on innovation and superior customer service.

CUSTOMER SERVICE

Warthog® Sewer Nozzles are sold exclusively through our network of Authorized Dealers

Good service means personal service. That's why you can only get Warthog products from an Authorized Warthog Dealer. Our Dealers provide you with competent advice, professional service and total customer care in all respects.



TECHNICAL SUPPORT

For technical support, please contact your local Authorized Dealer.

To find an Authorized Dealer near you, please visit: www.warthog-nozzles.com/LocationFinder.

You can also contact StoneAge directly for support or any other questions: **+1 (970) 259-2869**

DOCUMENTATION

Operator's manuals and repair videos for all equipment are available online to help illustrate tools, identify parts, and detail maintenance and overhaul procedures.

REPAIRS

Check with your nearest Authorized Dealer for questions and inquiries regarding repair.

Visit www.warthog-nozzles.com/LocationFinder for an Authorized Repair Center near you.

Repairs are also available through StoneAge Tools.

Visit: www.warthog-nozzles.com/support/service-repairs to request a Return Merchandise Authorization (RMA) number for return of any Warthog parts.



WV 2-4"

WT 3-6"

WX 3-8"

WS 4-8"

WH 6-18"

WG 8-36"

CENTRALIZERS

RESOURCES



WARNING



Operations with waterjetting equipment can be potentially hazardous. Caution **MUST** be exercised prior to and during machine and water jet tool use.

Please read and follow all of these instructions, in addition to the guidelines in the WJTA Recommended Practices handbook, available online at www.wjta.org. Deviating from safety instructions and recommended practices can lead to severe injury and/or death.

Do not exceed the maximum operating pressure specified for any component in a system.

The immediate work area **MUST** be marked off to keep out untrained persons.

Inspect the equipment for visible signs of deterioration, damage, and improper assembly. Do not operate if damaged, until repaired.

Make sure all threaded connections are tight and free of leaks.

Always de-energize the system before opening a door to service or replace any parts. Failure to do so can result in severe injury and/or death.

PRE-RUN SAFETY CHECK

Install mechanical stops, stingers and backout preventers as appropriate when doing any tube, pipe or vessel cleaning. See the WJTA-IMCA's Recommended Practices for the Use of High-Pressure Waterjetting Equipment and/or the Water Jetting Association's WJA Code of Practice for additional safety information.

Complete a job specific risk assessment and act on the resulting actions.

Adhere to all site specific safety procedures.

Ensure the waterjetting zone is properly barricaded and that warning signs are posted.

Ensure the work place is free of unnecessary objects (e.g. loose parts, hoses, tools).

Ensure all Operators are using the correct Personal Protective Equipment (PPE).

Check that the air hoses are properly connected and tight.

Check all hoses and accessories for damage prior to use. Do not use damaged items. Only high quality hoses intended for waterjetting applications should be used as high-pressure hoses.

Check all high-pressure threaded connections for tightness.

Operate the high-pressure water at full pressure and, if applicable, use the Pneumatic Foot Pedal Dump Control to verify that the dump valve is working properly.

Ensure that Operators never connect, disconnect, or tighten hoses, adapters, or accessories with the high-pressure water pump unit running.

Ensure no personnel are in the jetting zone.

PERSONAL PROTECTIVE EQUIPMENT

Use of Personal Protective Equipment (PPE) is dependent on the working pressure of water and the cleaning application. Managers, Supervisors, and Operators **MUST** carry out a job specific risk assessment to define the exact requirements for PPE. See Protective Equipment for Personnel (Section 6) of WJTA-IMCA's Recommended Practices For The Use Of High-pressure Water jetting Equipment for additional information.

Hygiene—Operators are advised to wash thoroughly after all waterjetting operations to remove any waterblast residue which may contain traces of harmful substances.

First aid provision—users **MUST** be provided with suitable first aid facilities at the operation site.

PPE MAY INCLUDE:

Eye protection: Full face visor

Foot protection: Kevlar® brand or steel toe capped, waterproof, non-slip safety boots

Hand protection: Waterproof gloves

Ear protection: Ear protection for a minimum of 85 dBA

Head protection: Hard hat that accepts a full face visor and ear protection

Body protection: Multi-layer waterproof clothing approved for water jetting

Hose protection: Hose shroud

Respiratory protection: May be required; refer to job specific risk assessment

StoneAge has designed and manufactured this equipment considering all hazards associated with its operation. StoneAge assessed these risks and incorporated safety features in the design. StoneAge WILL NOT accept responsibility for the results of misuse.

IT IS THE RESPONSIBILITY OF THE INSTALLER/OPERATOR to conduct a job specific risk assessment prior to use. Job specific risk assessment **MUST** be repeated for each different set up, material, and location.

The risk assessment **MUST** conform to the Health and Safety at Work Act 1974 and other relevant Health and Safety legislation.

The risk assessment **MUST** consider potential material or substance hazards including: **Aerosols, Biological and microbiological (viral or bacterial) agents, Combustible materials, Dusts, Explosion, Fibers, Flammable substances, Fluids, Fumes, Gases, Mists, Oxidizing Agents.**

TERMS & CONDITIONS

1. Acceptance of Terms and Conditions. Receipt of these Terms and Conditions of Sale ("Terms and Conditions") shall operate as the acceptance by StoneAge, Inc. ("Seller") of the order submitted by the purchaser ("Buyer"). Such acceptance is made expressly conditional on assent by Buyer to these Terms and Conditions. Such assent shall be deemed to have been given unless written notice of objection to any of these Terms and Conditions (including inconsistencies between Buyer's purchase order and this acceptance) is given by Buyer to Seller promptly on receipt hereof.

Seller desires to provide Buyer with prompt and efficient service. However, to individually negotiate the terms of each sales contract would substantially impair Seller's ability to provide such service. Accordingly, the product(s) furnished by Seller are sold only according to the terms and conditions stated herein and with the terms and conditions stated in any effective StoneAge Dealer Agreement or StoneAge Reseller Agreement, if applicable. Notwithstanding any terms and conditions on Buyer's order, Seller's performance of any contract is expressly made conditional on Buyer's agreement to these Terms and Conditions unless otherwise specifically agreed to in writing by Seller. In the absence of such agreement, commencement of performance, shipment and/or delivery shall be for Buyer's convenience only and shall not be deemed or construed to be an acceptance of Buyer's terms and conditions.

2. Payment/Prices. Unless other arrangements have been made in writing between Seller and Buyer, payment for the product(s) shall be made upon receipt of invoice. The prices shown on the face hereof are those currently in effect. Prices invoiced shall be per price list in effect at the time of shipment. Prices are subject to increase for inclusion of any and all taxes which are applicable and which arise from the sale, delivery or use of the product(s), and the collection of which Seller is or may be responsible to provide to any governmental authority, unless acceptable exemption certificates are provided by Buyer in accordance with applicable law. Buyer shall pay all charges for transportation and delivery and all excise, order, occupation, use or similar taxes, duties, levies, charges or surcharges applicable to the product(s) being purchased, whether now in effect or hereafter imposed by any governmental authority, foreign or domestic.

3. Warranty. SELLER MAKES NO WARRANTIES OR REPRESENTATIONS AS TO THE PERFORMANCE OF ANY PRODUCT EXCEPT AS SET FORTH IN THE STONEAGE LIMITED WARRANTY PROVIDED WITH THE PRODUCT.

4. Delivery. Seller is not obligated to make delivery by a specified date, but will always use its best efforts to make delivery within the time requested. The proposed shipment date is an estimate. Seller will notify Buyer promptly of any material delay and will specify the revised delivery date as soon as practicable. UNDER NO CIRCUMSTANCES SHALL SELLER HAVE ANY LIABILITY WHATSOEVER FOR LOSS OF USE OR FOR ANY DIRECT OR CONSEQUENTIAL DAMAGES RESULTING FROM DELAY REGARDLESS OF THE REASON(S).

All product(s) will be shipped F.O.B. point of origin, unless specifically agreed otherwise, and Buyer shall pay all shipping costs and insurance costs from that point. Seller, in its sole discretion, will determine and arrange the means and manner of transportation of the product(s). Buyer shall bear all risk of loss commencing with the shipment or distribution of the product(s) from Seller's warehouse. Order shortages or errors must be reported within fifteen (15) business days from receipt of shipment to secure adjustment. No product(s) may be returned without securing written approval from Seller.

5. Modification. These Terms and Conditions are intended by Seller and Buyer to constitute a final, complete and exclusive expression of agreement relating to the subject matter hereof and cannot be supplemented or amended without Seller's prior written approval.

6. Omission. Seller's waiver of any breach or Seller's failure to enforce any of these Terms and Conditions at any time, shall not in any way affect, limit or waive Seller's right thereafter to enforce and compel strict compliance with every term and condition hereof.

7. Severability. If any provision of these Terms and Conditions is held to be invalid or unenforceable, such invalidity or unenforceability shall not affect the validity or enforceability of the other portions hereof.

8. Disputes. Seller and Buyer shall attempt in good faith to promptly resolve any dispute arising under these Terms and Conditions by negotiations between representatives who have authority to settle the controversy. If unsuccessful, Seller and Buyer shall further attempt in good faith to settle the dispute by nonbinding third-party mediation, with fees and expenses of such mediation apportioned equally to each side. Any dispute not so resolved by negotiation or mediation may then be submitted to a court of competent jurisdiction in accordance with the terms hereof. These procedures are the exclusive procedures for the resolution of all such disputes between the Seller and Buyer.

9. Governing Law. All sales, agreements for sale, offers to sell, proposals, acknowledgments and contracts of sale, including, but not limited to, purchase orders accepted by Seller, shall be considered a contract under the laws of the State of Colorado and the rights and duties of all persons, and the construction and effect of all provisions hereof shall be governed by and construed according to the laws of such state.

10. Jurisdiction and Venue. Seller and Buyer agree that the state or federal courts located within the City and County of Denver, Colorado shall have sole and exclusive jurisdiction over any litigation concerning any dispute arising under these Terms and Conditions not otherwise resolved pursuant to Section 9 as well as any alleged defects of any Products or damages sustained as a result of such alleged defects. Seller and Buyer further agree that should any litigation be commenced in connection with such a dispute, it shall only be commenced in such courts. Seller and Buyer agree to the exclusive jurisdiction of such courts and neither will raise any objection to the jurisdiction and venue of such courts, including as a result of inconvenience.

11. Attorney's Fees. If any litigation is commenced between Seller and Buyer, or their personal representatives, concerning any provision hereof, the party prevailing in the litigation shall be entitled, in addition to such other relief that is granted, to a reasonable sum as and for their attorneys' fees and costs in such litigation or mediation.

STONEAGE PATENT DATA

View the list of StoneAge's current U.S. patent numbers and descriptions.

<https://www.stoneagetools.com/resource-center/patents>

STONEAGE TERMS AND WARRANTY

View StoneAge's Terms and Warranty Conditions online.

<https://www.warthog-nozzles.com/terms-use>

<https://www.warthog-nozzles.com/warranty>





WWW.WARTHOG-NOZZLES.COM